



BRDR. KRÜGER

DANISH CRAFT AND DESIGN

1886

Price List, Denmark, Q1 2026

Index

Tables	Bølling Collection , Hans Bølling	5-15
	HB Coffee Table , Hans Bølling	17
	Jari Low Collection , OEO Studio	19-24
	Orbis Table , O&M Design	25
	Jari Dining Table , OEO Studio	27-28
	Arv Dining Table , David Thulstrup	30-38
	TRIIIO Collection , Hans Bølling	40-42
Seating	Ekko Chair , Henning Larsen Architects	45
	HB Lounge Collection , Hans Bølling	47-48
	Arv Dining Chair , David Thulstrup	50-51
	Arv Lounge Chair , David Thulstrup	52
	Arkade Chair , Nanna Ditzel	55
	F-Chair , Rasmus B. Fex	57-62
	Pauline Bar Stool , OEO Studio	64-74
	Jari Dining Chair , OEO Studio	76
	Ferdinand Lounge Chair , OEO Studio	78
	Karm Sofa , Studio David Thulstrup	80-82
Lighting	Lune Collection , Sverre Uhnger	85-86
Complements	Samples	88
General Information	Sustainability	90
	Material Information	92-99
	Terms & Conditions	100-101

Tables









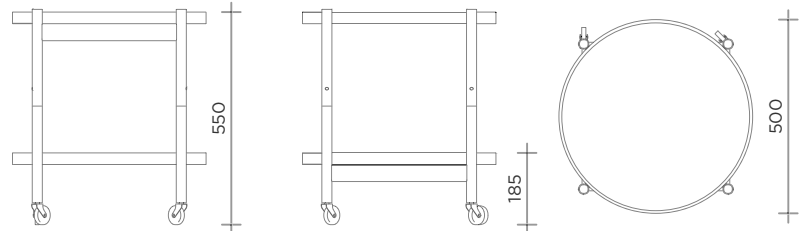







Bølling Tray Table

by Hans Bølling

Bølling Tray Table - Model 50
Hans Bølling



		DKK ex. VAT	DKK incl. VAT	#Reference
	Beech, Untreated	3.996	4.995	BBO1-BUN
	Beech, Oiled	4.596	5.745	BBO1-BOL
	Oak, Untreated	4.716	5.895	BBO1-OUN
	Oak, Oiled	5.316	6.645	BBO1-OOL
	Oak, Black Lacquer	7.356	9.195	BBO1-OBA
	Fumed Oak, Oiled	5.596	6.995	BBO1-OFU
	Walnut, Oiled	7.116	8.895	BBO1-WOL

Tray Colour	# Reference
	BASE (Black / White) BA
	STONE (Grey / Dark Grey) ST
	EARTH (Beige / Brown) EA
	LEAF (Green / Dark Green) LE
	WATER (Blue / Dark Blue) WA
	CLAY (Cognac/ Black) CL
	RED (Red / Black) RE

Dimensions	
Diameter	Ø500 mm
Height	550 mm
Tray Height	30 mm
Box	790 x 130 x 580 mm
Weight	4,5 kg

Notes:

- Shipped flat packed.
- Ready to assemble, no tools needed.
- Handling cost of choosing two different colour combinations is 500 DKK. net, ex. VAT

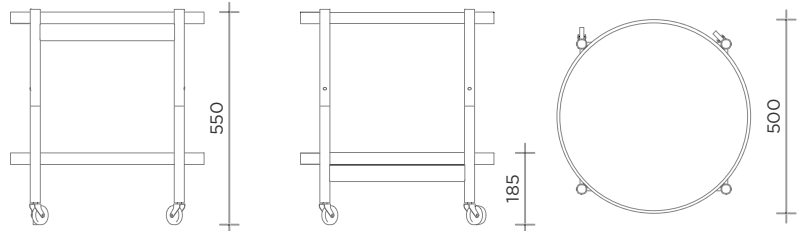

	DKK ex. VAT	DKK incl. VAT	#Reference
 Oak, Indigo Blue Lacquered	6.320	7.900	BB01-OBU-VV







Dimensions







Diameter	Ø500 mm
Height	550 mm
Tray Height	30 mm
Box	790 x 130 x 580 mm
Weight	4,5 kg

Notes:

- Only for Selected Distributors.
- Every Tray Table is mounted with a brass plate that contains Hans Bølling's signature and has the individual piece number engraved as a certificate of authenticity.
- Limited quantities available.









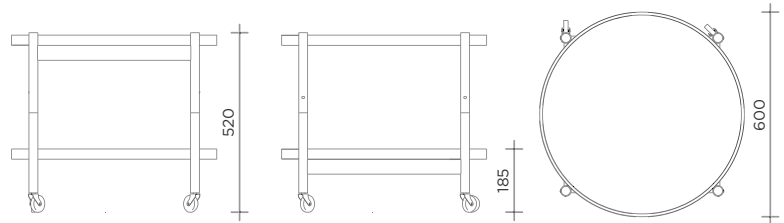







		DKK ex. VAT	DKK incl. VAT	#Reference
	Beech, Untreated	1.332	1.665	BBB1-BUN
	Beech, Oiled	1.532	1.915	BBB1-BOL
	Oak, Untreated	1.572	1.965	BBB1-OUN
	Oak, Oiled	1.772	2.215	BBB1-OOL
	Oak, Black Lacquer	2.456	3.007	BBB1-OBA
	Fumed Oak, Oiled	1.868	2.335	BBB1-OFU
	Walnut, Oiled	2.372	2.965	BBB1-WOL

Tray Colour	# Reference	Dimensions
 BASE (Black / White)	BA	Diameter Ø500 mm
 STONE (Grey / Dark Grey)	ST	Height 30 mm
 EARTH (Beige / Brown)	EA	Box 520 x 520 x 40 mm
 LEAF (Green / Dark Green)	LE	Weight 2 kg
 WATER (Blue / Dark Blue)	WA	
 CLAY (Cognac/ Black)	CL	
 RED (Red / Black)	RE	

Bølling Tray Table - Model 60
Hans Bølling



		DKK ex. VAT	DKK incl. VAT	#Reference
	Beech, Untreated	4.796	5.995	BBO3-BUN
	Beech, Oiled	5.396	6.745	BBO3-BOL
	Oak, Untreated	5.676	7.095	BBO3-OUN
	Oak, Oiled	6.276	7.845	BBO3-OOL
	Oak, Black Lacquer	8.796	10.995	BBO3-OBA
	Fumed Oak, Oiled	7.196	8.995	BBO3-OFU
	Walnut, Oiled	8.540	10.675	BBO3-WOL







Tray Colour	# Reference
	BASE (Black / White) BA
	STONE (Grey / Dark Grey) ST
	EARTH (Beige / Brown) EA
	LEAF (Green / Dark Green) LE
	WATER (Blue / Dark Blue) WA
	CLAY (Cognac / Black) CL
	RED (Red / Black) CL







Dimensions	
Diameter	Ø600 mm
Height	520 mm
Tray Height	25 mm
Box	900 x 120 x 650 mm
Weight	5,5 kg

Notes:

- Shipped flat packed.
- Ready to assemble, no tools needed.
- Handling cost of choosing two different colour combinations is 500 DKK. net, ex. VAT



		DKK ex. VAT	DKK incl. VAT	#Reference
	Beech, Untreated	1.600	2.000	BBB2-BUN
	Beech, Oiled	1.800	2.250	BBB2-BOL
	Oak, Untreated	1.892	2.365	BBB2-OUN
	Oak, Oiled	2.092	2.615	BBB2-OOL
	Oak, Black Lacquer	2.932	3.665	BBB2-OBA
	Fumed Oak, Oiled	2.400	3.000	BBB2-OFU
	Walnut, Oiled	2.848	3.560	BBB2-WOL

	Tray Colour	# Reference
	BASE (Black / White)	BA
	STONE (Grey / Dark Grey)	ST
	EARTH (Beige / Brown)	EA
	LEAF (Green / Dark Green)	LE
	WATER (Blue / Dark Blue)	WA
	CLAY (Cognac / Black)	CL
	RED (Red / Black)	RE

Dimensions	
Diameter	Ø600 mm
Height	25 mm
Box	620 x 620 x 40 mm
Weight	2,5 kg





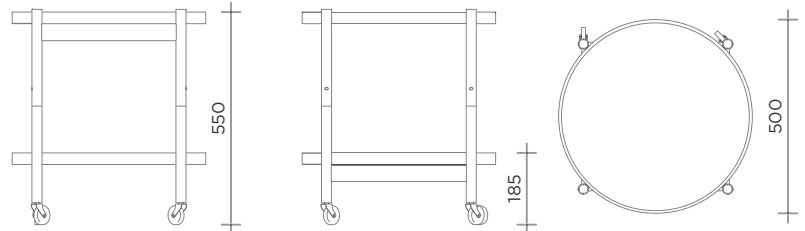

Bølling Veneer Tray Table

by Hans Bølling

Bølling Tray Table - Veneer Model 50
Hans Bølling



	DKK ex. VAT	DKK incl. VAT	#Reference
 Beech, Oiled	5.196	6.495	BBO1-BOL-VV
 Oak, Oiled	5.916	7.395	BBO1-OOL-VV
 Oak, Black Lacquer	7.944	9.930	BBO1-OBA-VV
 Fumed Oak, Oiled	6.396	7.995	BBO1-OFU-VV
 Walnut, Oiled	7.716	9.645	BBO1-WOL-VV





Dimensions

Diameter	Ø500 mm
Height	550 mm
Tray Height	30 mm
Box	790 x 130 x 580 mm
Weight	4,5 kg

Notes:

- Shipped flat packed.
- Ready to assemble, no tools needed.
- Both sides of the trays are made of veneer.
- Handling cost of choosing two different colour combinations is 500 DKK. net, ex. VAT







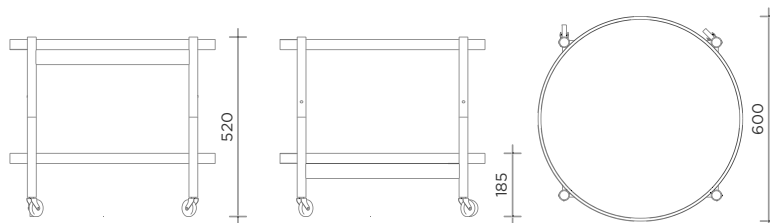

		DKK ex. VAT	DKK incl. VAT	#Reference
	Beech, Oiled	1.732	2.165	BBB1-BOL-VV
	Oak, Oiled	1.972	2.465	BBB1-OOL-VV
	Oak, Black Lacquer	2.648	3.310	BBB1-OBA-VV
	Fumed Oak, Oiled	2.132	2.665	BBB1-OFU-VV
	Walnut, Oiled	2.572	3.215	BBB1-WOL-VV

Dimensions

Diameter	Ø500 mm
Height	30 mm
Box	520 x 520 x 40 mm
Weight	2 kg

Bølling Tray Table - Veneer Model 60
Hans Bølling



	DKK ex. VAT	DKK incl. VAT	#Reference
 Beech, Oiled	6.196	7.745	BBO3-BOL-VV
 Oak, Oiled	7.076	8.845	BBO3-OOL-VV
 Oak, Black Lacquer	9.624	12.030	BBO3-OBA-VV
 Fumed Oak, Oiled	7.996	9.995	BBO3-OFU-VV
 Walnut, Oiled	9.340	11.675	BBO3-WOL-VV





Dimensions

Diameter	Ø600 mm
Height	520 mm
Tray Height	25 mm
Box	900 x 120 x 650 mm
Weight	5,5 kg

Notes:

- Shipped flat packed.
- Ready to assemble, no tools needed.
- Both sides of the trays are made of veneer.
- Handling cost of choosing two different colour combinations is 500 DKK. net, ex. VAT



		DKK ex. VAT	DKK incl. VAT	#Reference
	Beech, Oiled	2.064	2.580	BBB2-BOL-VV
	Oak, Oiled	2.360	2.950	BBB2-OOL-VV
	Oak, Black Lacquer	3.208	4.010	BBB2-OBA-VV
	Fumed Oak, Oiled	2.664	3.330	BBB2-OFU-VV
	Walnut, Oiled	3.120	3.900	BBB2-WOL-VV

Dimensions

Diameter	Ø600 mm
Height	25 mm
Box	620 x 620 x 40 mm
Weight	2,5 kg



	DKK ex. VAT	DKK incl. VAT	#Reference
Wheel Set for Bølling Tray Table	316	395	BBhjul

Note:

Set with 4 wheels.



HB Coffee Table

by Hans Bølling

HB Coffee Table
Hans Bølling

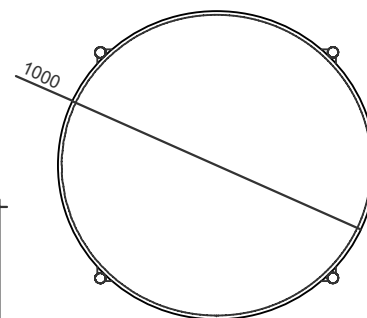
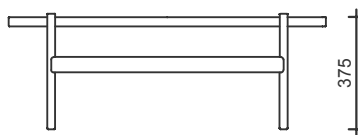

	DKK ex. VAT	DKK incl. VAT	#Reference
Oak, Oiled	10.708	13.385	BO09-OOL
Fumed Oak, Oiled	11.908	14.885	BO09-OFU
Maple, White Oiled	10.708	13.385	BO09-MWO
Cherry, Oiled	11.908	14.885	BO09-COL

Dimensions

Diameter	Ø1000 mm
Height	375 mm
Tray Height	30 mm
Box	1020 x 1020 x 380 mm
Weight	12 kg

Notes:

- Maple and Cherry will be discontinued once current inventory is depleted.



Jari Table Collection

by OEO Studio

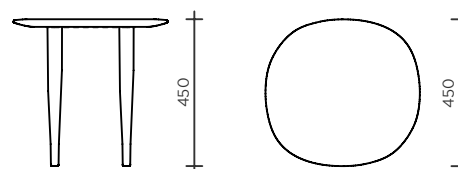

	DKK ex. VAT	DKK incl. VAT	#Reference
 Oak, Oiled	7.868	9.835	JAJ1-OOL
 Fumed Oak, Oiled	8.468	10.585	JAJ1-OFU

Notes:

- Shipped flat packed.
- Ready to assemble, no tools needed.
- Different leg length than standard incurs an extra charge of 500 DKK net, ex. VAT.
- Fumed colors will vary across the table.
Read more under material information.

Dimensions

Diameter	Ø450 mm
Height	450 mm
Table Top Thickness	25 mm
Box (top)	470 x 470 x 40 mm
Box (legs)	470 x 160 x 110 mm
Weight	5 kg

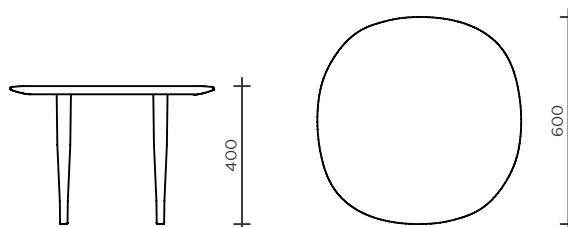

	DKK ex. VAT	DKK incl. VAT	#Reference
 Oak, Oiled	8.904	11.130	JAJ2-OOL
 Fumed Oak, Oiled	9.504	11.880	JAJ2-OFU

Notes:

- Shipped flat packed.
- Ready to assemble, no tools needed.
- Different leg length than standard incurs an extra charge of 500 DKK net, ex. VAT.
- Fumed colors will vary across the table.
Read more under material information.

Dimensions

Diameter	Ø600 mm
Height	400 mm
Table Top Thickness	25 mm
Box (top)	630 x 630 x 40 mm
Box (legs)	470 x 160 x 110 mm
Weight	8 kg

Jari Coffee Table Round - Model C85

OEO Studio

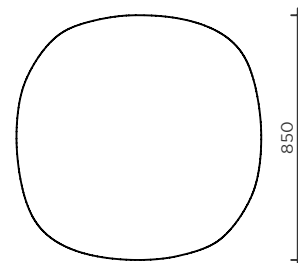
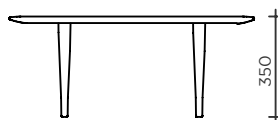

	DKK ex. VAT	DKK incl. VAT	#Reference
 Oak, Oiled	10.368	12.960	JAJ3-OOL
 Fumed Oak, Oiled	10.968	13.710	JAJ3-OFU

Notes:

- Shipped flat packed.
- Ready to assemble, no tools needed.
- Different leg length than standard incurs an extra charge of 500 DKK net, ex. VAT.
- Fumed colors will vary across the table.
Read more under material information.

Dimensions

Diameter	Ø850 mm
Height	350 mm
Table Top Thickness	25 mm
Box (top)	930 x 930 x 40 mm
Box (legs)	370 x 160 x 110 mm
Weight	15 kg

Jari Coffee Table Round - Model C118

OEO Studio



	DKK ex. VAT	DKK incl. VAT	#Reference
 Oak, Oiled	16.608	20.760	JAJ4-OOL
 Fumed Oak, Oiled	18.008	22.510	JAJ4-OFU

Notes:

- Shipped flat packed.
- Ready to assemble, no tools needed.
- Different leg length than standard incurs an extra charge of 500 DKK net, ex. VAT.
- Fumed colors will vary across the table.
Read more under material information.

Dimensions

Diameter	Ø1180 mm
Height	250 mm
Table Top Thickness	25 mm
Box (top)	1250 x 1250 x 40
Box (legs)	370 x 160 x 110 mm
Weight	18 kg

Jari Ellipse Coffee Table - Model E130
OEO Studio

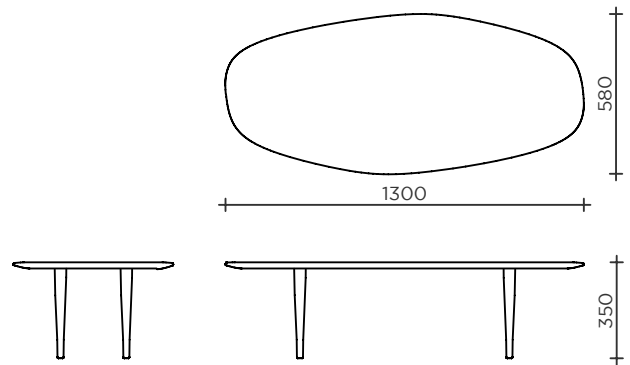

	DKK ex. VAT	DKK incl. VAT	#Reference
 Oak, Oiled	15.548	19.435	JAJ5-OOL
 Fumed Oak, Oiled	16.948	21.185	JAJ5-OFU

Notes:

- Shipped flat packed.
- Ready to assemble, no tools needed.
- Different leg length than standard incurs an extra charge of 500 DKK net, ex. VAT.
- Fumed colors will vary across the table.
Read more under material information.

Dimensions

Length	1300 mm
Width	580 mm
Height	350 mm
Table Top Thickness	25 mm
Box (top)	1330 x 610 x 40 mm
Box (legs)	370 x 160 x 110 mm
Weight	18 kg

Jari Ellipse Coffee Table - Model E180
OEO Studio



	DKK ex. VAT	DKK incl. VAT	#Reference
 Oak, Oiled	20.116	25.145	JAJ6-OOL
 Fumed Oak, Oiled	23.116	28.895	JAJ6-OFU

Notes:

- Shipped flat packed.
- Ready to assemble, no tools needed.
- Different leg length than standard incurs an extra charge of 500 DKK net, ex. VAT.
- Fumed colors will vary across the table.
Read more under material information.

Dimensions

Length	1800 mm
Width	800 mm
Height	250 mm
Table Top Thickness	25 mm
Box (top)	1830 x 830 x 40
Box (legs)	370 x 160 x 110 mm
Weight	25 kg

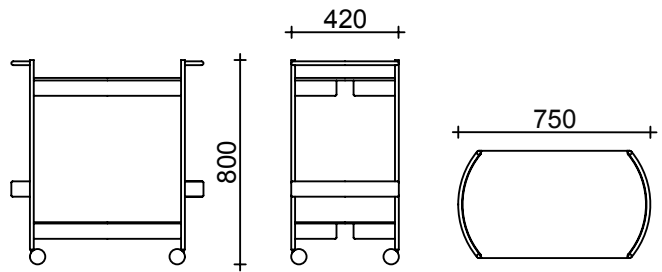

	DKK ex. VAT	DKK incl. VAT	#Reference
Stainless Steel, Tempered Glass	16.364	20.455	OMS2-CG

Notes:

- Shipped flat packed.
- Must be assembled, tools are included.
- Loose trays.

Dimensions

Length	750 mm
Width	420 mm
Height	800 mm
Box	820 x 500 x 160 mm
Weight	25 kg



Jari Dining Table

by OEO Studio

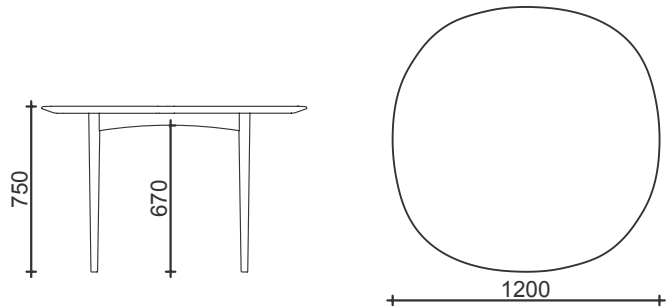

	DKK ex. VAT	DKK incl. VAT	#Reference
 Oak, Oiled	27.000	33.750	JAO6-OOL
 Fumed Oak, Oiled	30.300	37.875	JA06-OFU

Notes:

- Approved for hotel / restaurant (EN 15372: 2016, Test level 2 General)
- Fumed colors will vary across the table. Read more under material information.
- Shipped knock down.

Dimensions

Diameter	Ø1200 mm
Height	750 mm
Solid Wood Table Top Thickness	30 mm
Box	1240 x 1240 x 140 mm
Weight	60 kg

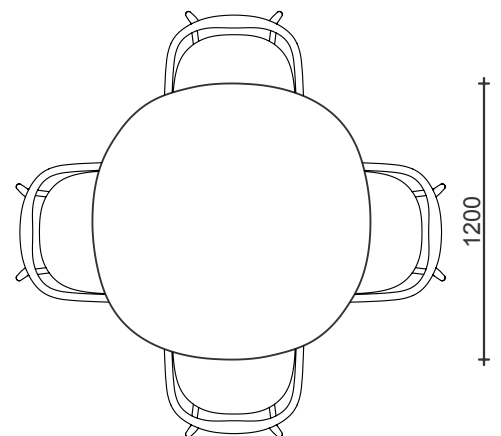

Jari Ellipse Dining Table - Model E240
OEO Studio

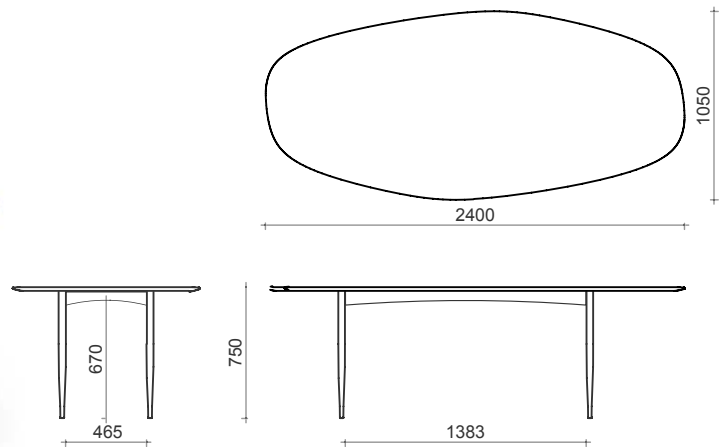

	DKK ex. VAT	DKK incl. VAT	#Reference
 Oak, Oiled	42.000	52.500	JAT3-OOL
 Fumed Oak, Oiled	48.000	60.000	JAT3-OFU

Notes:

- Approved for hotel / restaurant (EN 15372: 2016, Test level 2 General)
- Fumed colors will vary across the table. Read more under material information.
- Shipped knock down.

Dimensions

Length	2400 mm
Width	1050 mm
Height	750 mm
Solid Wood Table Top Thickness	30 mm
Box	2450 x 1100 x 140 mm
Weight	80 kg

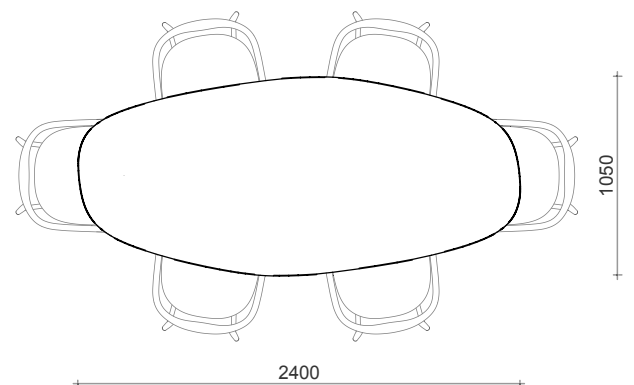





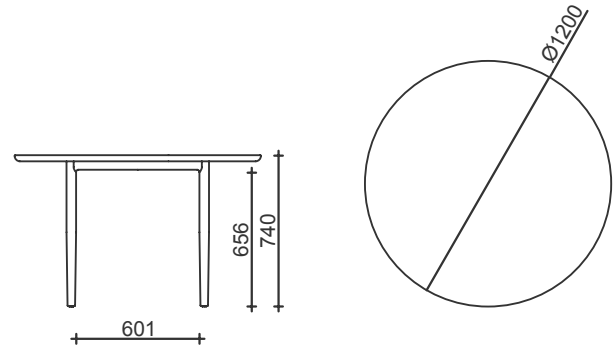

Arv Dining Table

by David Thulstrup

ARV Dining Table - Ø 120 cm
David Thulstrup



	DKK ex. VAT	DKK incl. VAT	#Reference
 Oak, White Oiled	33.248	41.560	AVO6-OWO
 Oak, Oiled	33.248	41.560	AVO6-OOL
 Fumed Oak, Oiled	36.548	45.685	AVO6-OFU
<hr/>			
120 Wooden Expo Box	1.500	1.875	BOX120

Notes:

- Approved for hotel / restaurant (EN 15372: 2016, Test level 2 General)
- Fumed colors will vary across the table. Read more under material information.
- Shipped assembled.
- When making purchases outside Denmark, using the expo box is required unless the client prefers to pick up the items themselves.
- Contact Brdr. Krüger for custom sizes.

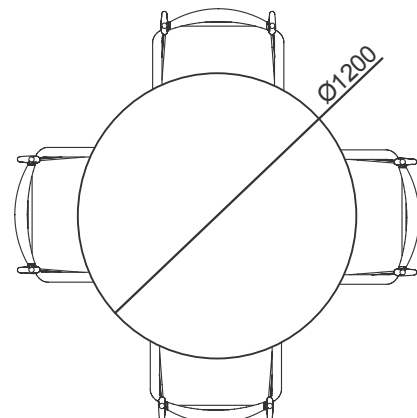

Dimensions

Diameter	Ø1200 mm
Height	740 mm
Solid Oak Table Top Thickness	260 mm
Export Box	1230 x 1230 x 930 mm
Weight (including box)	75 kg

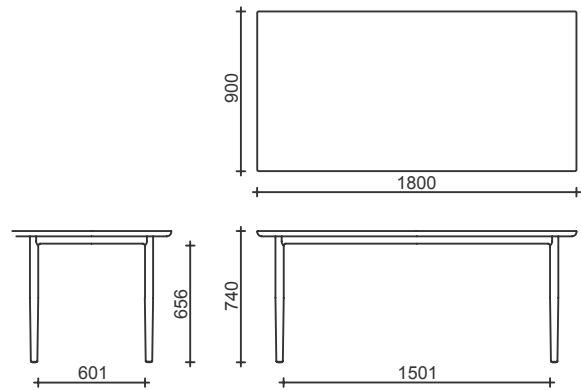

ARV Dining Table - 90x180 cm
David Thulstrup



	DKK ex. VAT	DKK incl. VAT	#Reference
 Oak, White Oiled	42.748	53.435	AVT1-OWO
 Oak, Oiled	42.748	53.435	AVT1-OOL
 Fumed Oak, Oiled	47.148	58.935	AVT1-OFU
<hr/>			
180 Wooden Expo Box	1.748	2.185	BOX180

Notes:

- Approved for hotel / restaurant (EN 15372: 2016, Test level 2 General)
- Fumed colors will vary across the table. Read more under material information.
- Shipped assembled.
- When making purchases outside Denmark, using the expo box is required unless the client prefers to pick up the items themselves.
- Contact Brdr. Krüger for custom sizes.

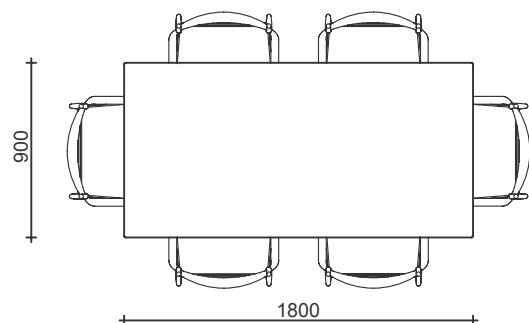

Dimensions

Length	1800 mm
Width	900 mm
Height	740 mm
Solid Oak Table Top Thickness	26 mm
Export Box	1830 x 930 x 93 mm
Weight (including box)	100 kg

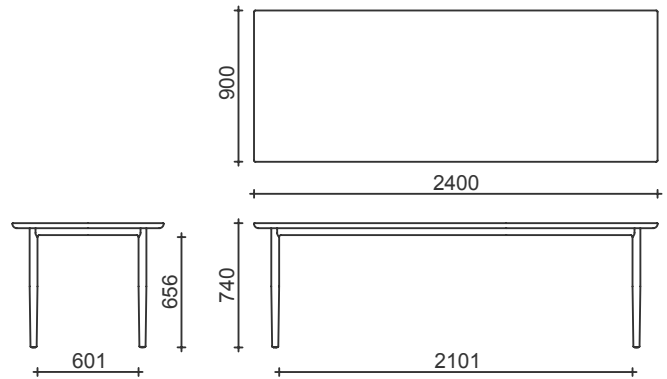

ARV Dining Table - 90x240 cm
David Thulstrup



	DKK ex. VAT	DKK incl. VAT	#Reference
 Oak, White Oiled	48.296	60.370	AVT2-OWO
 Oak, Oiled	48.296	60.370	AVT2-OOL
 Fumed Oak, Oiled	54.296	67.870	AVT2-OFU
<hr/>			
240 Wooden Expo Box	2.448	3.060	BOX240

Notes:

- Approved for hotel / restaurant (EN 15372: 2016, Test level 2 General)
- Fumed colors will vary across the table. Read more under material information.
- Shipped assembled.
- When making purchases outside Denmark, using the expo box is required unless the client prefers to pick up the items themselves.
- Contact Brdr. Krüger for custom sizes.

Dimensions

Length	2400 mm
Width	900 mm
Height	740 mm
Solid Oak Table Top Thickness	26 mm
Export Box	2430 x 930 x 930 mm
Weight (including box)	125 kg

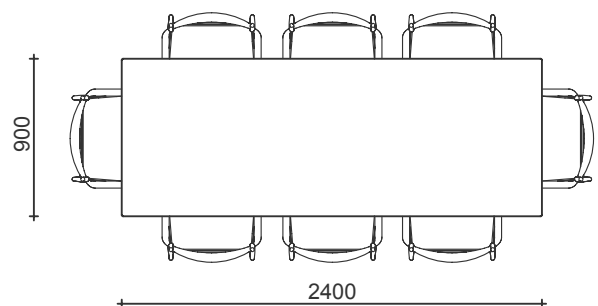



Arv Plus Table

by David Thulstrup

ARV Dining Table - 107x314 cm
David Thulstrup

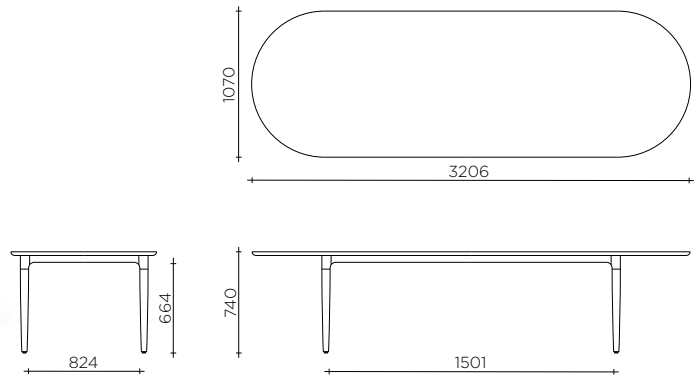

	DKK ex. VAT	DKK incl. VAT	#Reference
Oak, White Oiled	98.400	123.000	AVT3-OWO
Oak, Oiled	98.400	123.000	AVT3-OOL
Fumed Oak, Oiled	112.000	140.000	AVT3-OFU

Notes:

- The table comes knock-down for easier transport and handling.
- Cable management options are available.
- Bespoke sizes are available, up to 6 meters.
- Contact Brdr. Krüger for custom sizes.

Dimensions

Length	3206 mm
Width	1070 mm
Height	740 mm
Solid Oak Table Top Thickness	26 mm
Box	3300 x 1080 x 25
Weight (including box)	135 kg

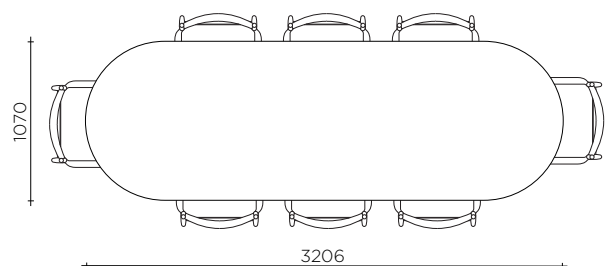

ARV Dining Table - Bespoke 8/10 seater
David Thulstrup

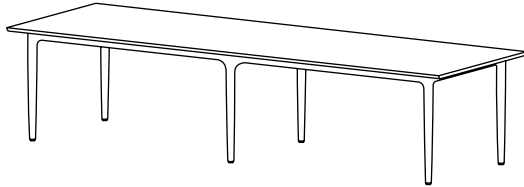

• Frame 1

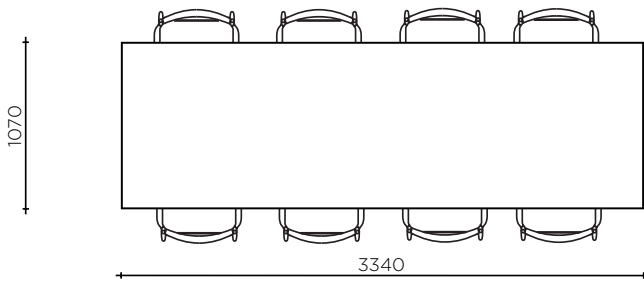

• Table Top A

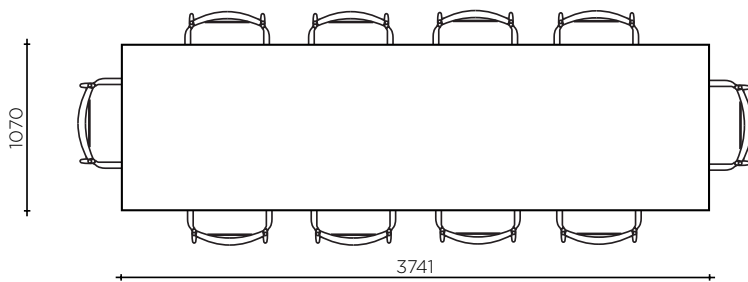

• Table Top B

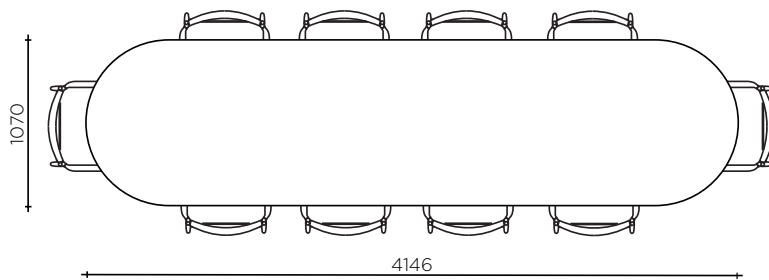

• Table Top C,
rounded ends

Notes:

- The table comes knock-down
- Cable management options are available.
- Contact Brdr. Krüger for prices.

ARV Dining Table - Bespoke 10/12 seater
David Thulstrup

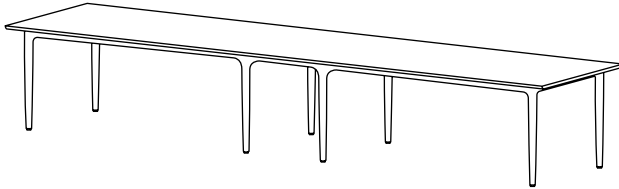

• Frame 2

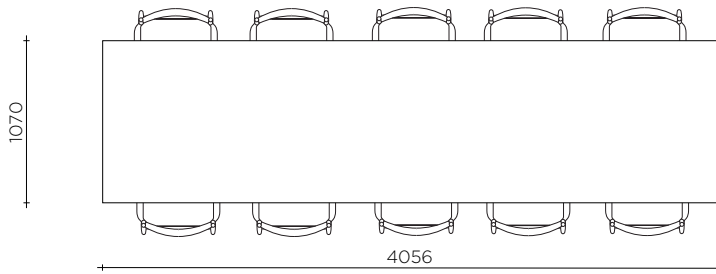

• Table Top A

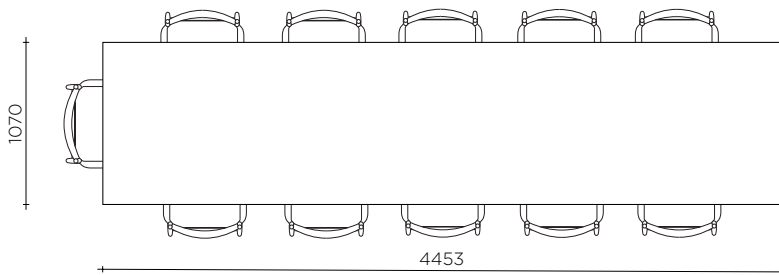

• Table Top B

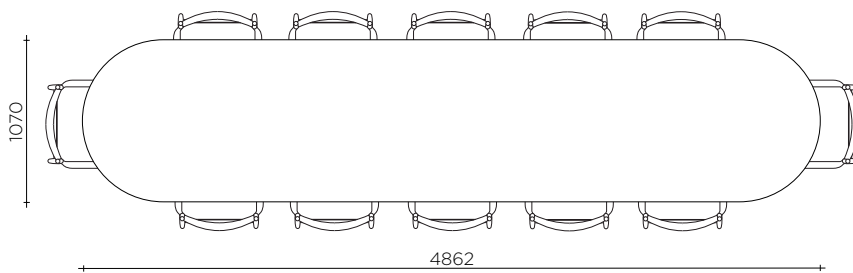

• Table Top C,
rounded ends

Notes:

- The table comes knock-down
- Cable management options are available.
- Contact Brdr. Krüger for prices.

ARV Dining Table - Bespoke 12/14 seater
David Thulstrup

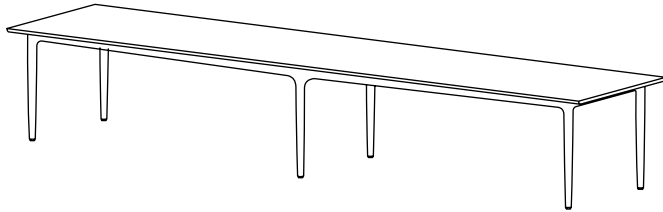

• Frame 3

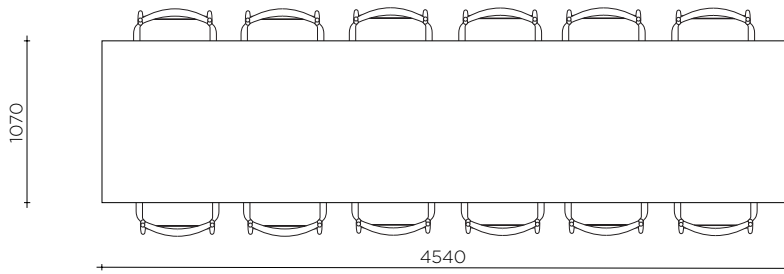

• Table Top A

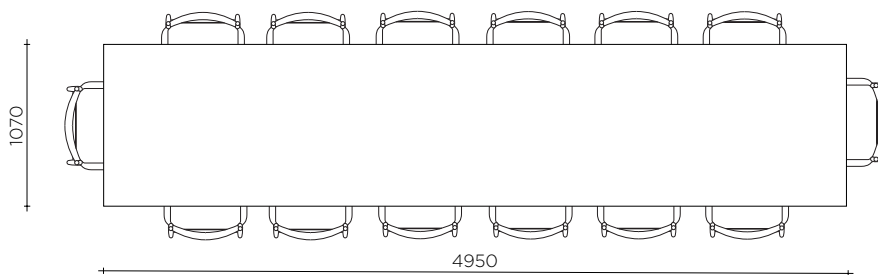

• Table Top B

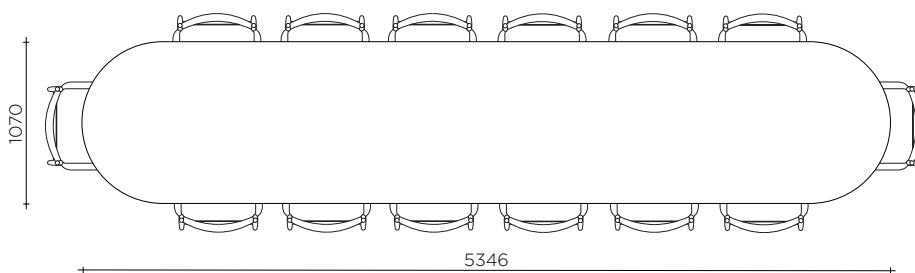

• Table Top C,
rounded ends

Notes:

- The table comes knock-down
- Cable management options are available.
- Contact Brdr. Krüger for prices.

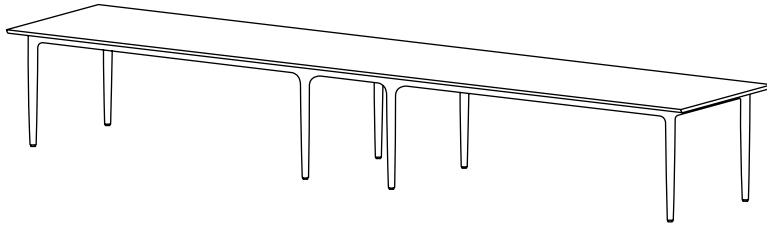

• Frame 4

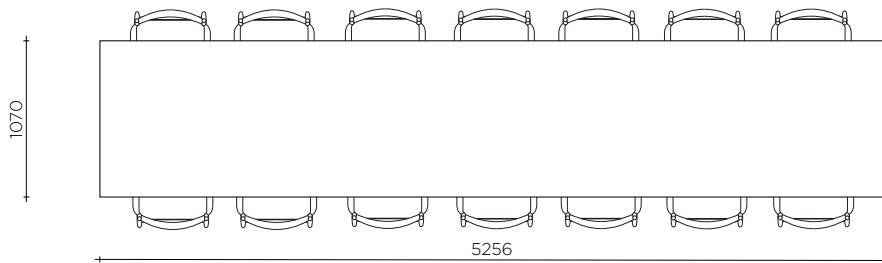

• Table Top A

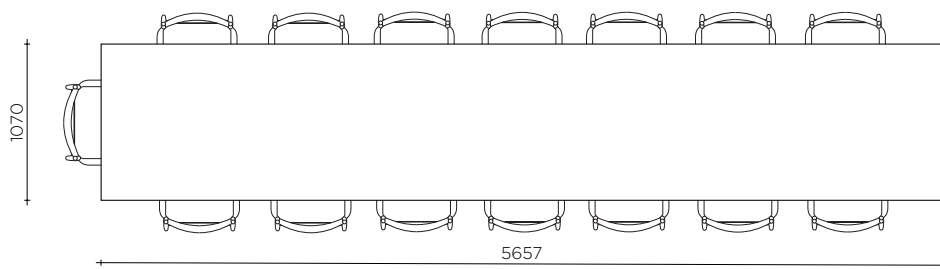

• Table Top B

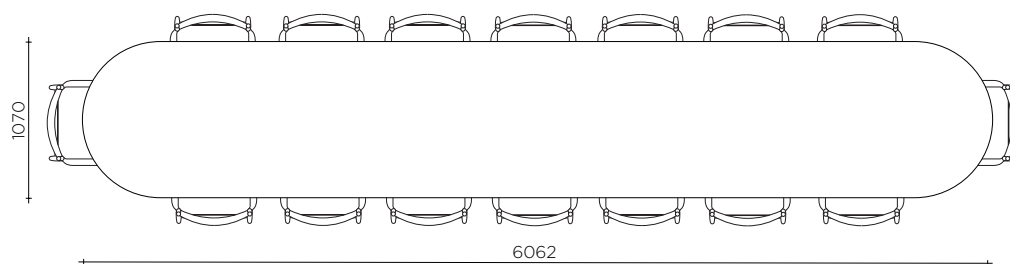

• Table Top C,
rounded ends

Notes:

- The table comes knock-down
- Cable management options are available.
- Contact Brdr. Krüger for prices.



TRIIIIO Table Collection

by Hans Bølling

TRIIIIO Coffee Table
Hans Bølling

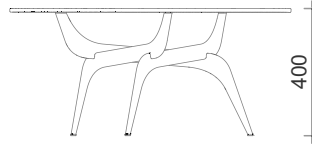

	DKK ex. VAT	DKK incl. VAT	#Reference
 Oak, Oiled	10.664	13.330	TRO5-OOL
 Fumed Oak, Oiled	12.136	15.170	TRO5-OFU
 Walnut, Oiled	15.992	19.990	TRO5-WOL

Glass Colour	# Reference
 Clear	CG
 Bronze	BG



Dimension	
Diameter	Ø900 mm
Height	410 mm
Hardened Glass Thickness	10 mm
Box (glass)	935 x 935 x 60 mm
Box (legs)	810 x 260 x 70 mm
Total Weight	18 kg

Notes:

- Shipped flat packed.
- Ready to assemble, no tools needed.
- Fumed colors will vary across the table.
Read more under material information.

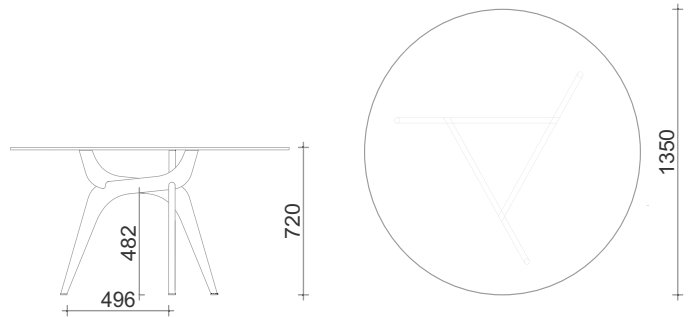
TRIIIØ Dining Table - Ø135 cm
Hans Bølling



	DKK ex. VAT	DKK incl. VAT	#Reference
 Oak, Oiled	28.636	35.795	TRO7-OOL
 Fumed Oak, Oiled	30.636	38.295	TRO7-OFU
 Walnut, Oiled / Out of collection in June 2025	42.968	53.710	TRO7-WOL

Glass Colour	# Reference
 Clear	CG
 Bronze	BG

Dimensions	
Diameter	Ø1350 mm
Height	720 mm
Hardened Glass Thickness	10 mm
Box (glass)	1360 x 1360 x 35 mm
Box (legs)	860 x 860 x 800 mm
Total Weight	55,5 kg

Notes:

- Shipped flat packed.
- Ready to assemble, no tools needed.
- Fumed colors will vary accross the table.
Read more under material information.

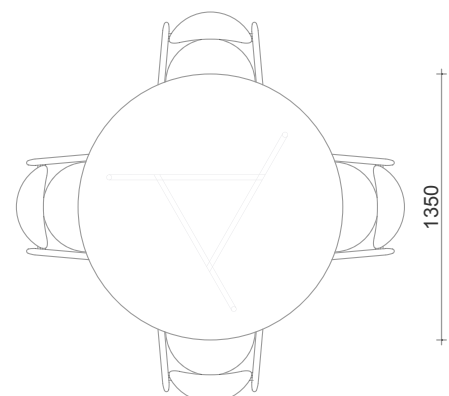

TRIIIIO Dining Table - Solid Table Top Ø120 cm
 Hans Bølling

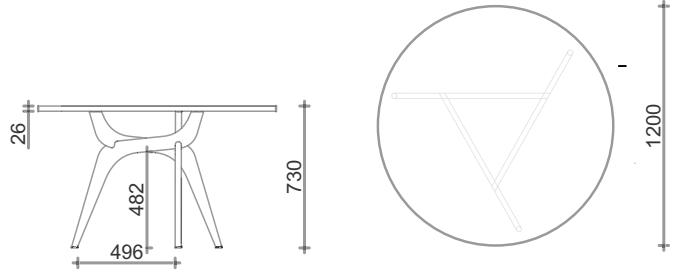

	DKK ex. VAT	DKK incl. VAT	#Reference
 Oak, Oiled	28.636	35.795	TRO6-OOL-OT
 Fumed Oak, Oiled	30.636	38.295	TRO6-OFU-OT

Notes:

- Shipped assembled.
- If requested, shipped flat pack.
- Ready to assemble, no tools needed.
- Fumed colors will vary accross the table.
 Read more under material information.

Dimensions

Diameter	Ø1200 mm
Height	730 mm
Solid Oak Table Top Thickness	26 mm
Box (top)	1220 x 1220 x 50 mm
Box (legs)	860 x 860 x 800 mm
Total Weight	54 kg

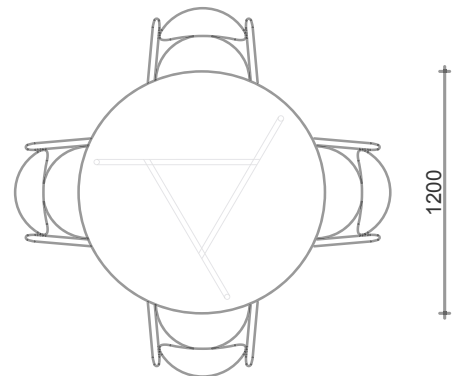

Seating



Ekko Chair

by Henning Larsen Architects

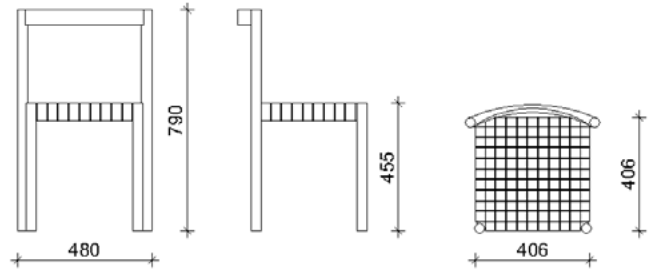



Natural Linen Webbing Seat

	DKK ex. VAT	DKK incl. VAT	#Reference
 Oak, Oiled	4.000	5.000	EKCX-OOL-07
 Fumed Oak, Oiled	4.400	5.500	EKCX-OFU-07

Veneer Seat

 Oak, Oiled,	4.000	5.000	EKCX-OOL-03
 Fumed Oak, Oiled	4.400	5.500	EKCX-OFU-03

Upholstered Seat

 Oak, Oiled, Spectrum - Almond Leather 30150	4.500	5.625	EKCX-OOL-63
 Fumed Oak, Oiled, Spectrum - Almond Leather 30150	4.900	6.125	EKCX-OFU-63

Notes:

- EN 16139: Extreme use: E.g. in night-clubs, police stations, transport, churches, terminals, sport changing rooms, prisons, barracks.
- It is stackable, up to 8 chairs.

Dimensions

Height	790 mm
Seat Width	406 mm
Seat Depth	406 mm
Box	490 x 490 x 800 mm
Weight	6 kg





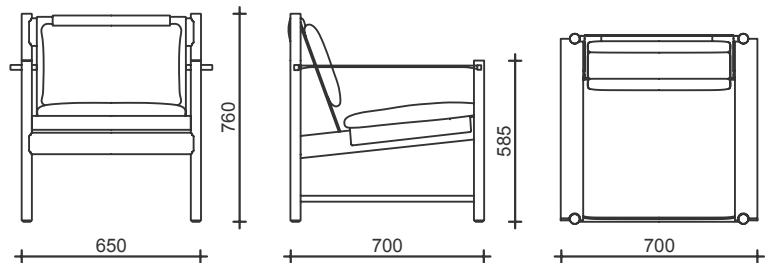

HB Lounge Chair

by Hans Bølling

HB Lounge Chair
Hans Bølling



	Canvas frame / Canvas seat and backrest cushion	DKK ex. VAT	DKK incl. VAT	#Reference
	Oak, Oiled	17.276	21.595	BOCL-OOL
	Fumed Oak, Oiled	18.476	23.095	BOCL-OFU
	Maple, White Oiled	17.276	21.595	BOCL-MWO
	Cherry, Oiled	18.476	23.095	BOCL-COL

Canvas frame / Leather seat and backrest cushion

	Oak, Oiled	20.276	25.345	BOCL-OOL
	Fumed Oak, Oiled	21.476	26.845	BOCL-OFU
	Maple, White Oiled	20.276	25.345	BOCL-MWO
	Cherry, Oiled	21.476	26.845	BOCL-COL

Upholstery

Reference

	Canvas	06
	Spectrum, Brandy Leather - 30155	66





Notes:

- The COM option for cushions adds 1.500 DKK plus material to the net price.
- Maple and Cherry will be discontinued once current inventory is depleted.

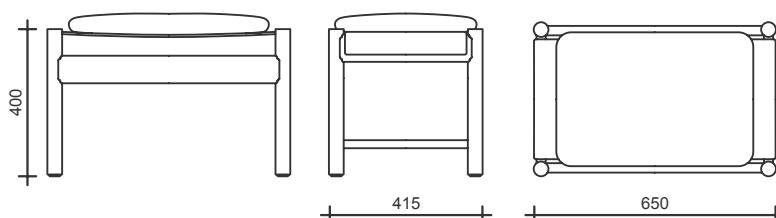
Dimensions

Height	760 mm
Width	700 mm
Seat Depth	536 mm
Seat Height	566 mm
Box	740 x 720mx 800 mm
Weight	15 kg



Canvas frame	DKK ex. VAT	DKK incl. VAT	#Reference
 Oak, Oiled	4.424	5.530	B040-OOL
 Fumed Oak, Oiled	5.596	6.995	BO40-OFU
 Maple, White Oiled	4.424	5.530	BO40-MWO
 Cherry, Oiled	5.596	6.995	BO40-COL

Cushion

HB Stool Cushion - Canvas Textile	1.036	1.295	BOCC-06
HB Stool Cushion - Spectrum, Brandy Leather	1.996	2.495	BOCC-66

Notes:

- The COM option for cushions adds 1.000 DKK plus material to the net price.
- Maple and Cherry will be discontinued once current inventory is depleted.

Dimensions

Height	400 mm
Length	650 mm
Width	415 mm
Box	670 x 460 x 430 mm
Weight	4 kg



Arv Chair

by David Thulstrup

Arv Dining Chair
David Thulstrup

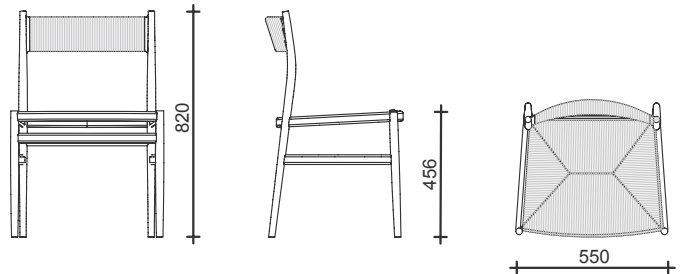

Weaved Seat, Weaved Back

	DKK ex. VAT	DKK incl. VAT	#Reference
 Oak, White Oiled	8.796	10.995	AVCX-OWO-02
 Oak, Oiled	8.796	10.995	AVCX-OOL-02
 Fumed Oak, Oiled	9.896	12.370	AVCX-OFU-02

Weaved Seat, Solid Back

 Oak, White Oiled	8.796	10.995	AVCX-OWO-01
 Oak, Oiled	8.796	10.995	AVCX-OOL-01
 Fumed Oak, Oiled	9.896	12.370	AVCX-OFU-01

Notes:

- The COM option for seat adds 1.500 DKK plus material to the net price.
- Approved EN 16139 for extreme use.
- Felt gliders.
- Fumed colors will vary across the chair as the wood content of tanin will vary.
Read more under material information.

Dimensions

Height	820 mm
Width	550 mm
Seat Height	460 mm
Seat Depth	450 mm
Box	630 x 590 x 900 mm
Weight	7 kg

ARV Dining Chair with Armrest
David Thulstrup

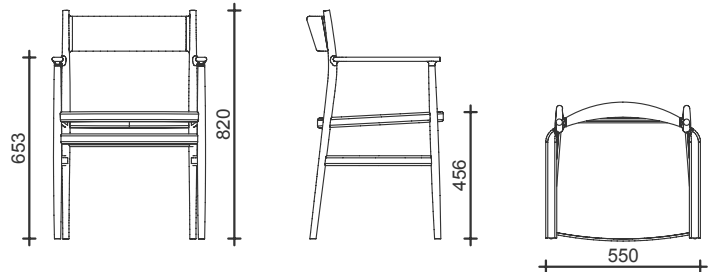

Weaved Seat, Weaved Back

	DKK ex. VAT	DKK incl. VAT	#Reference
 Oak, White Oiled	10.776	13.470	AVCA-OWO-02
 Oak, Oiled	10.776	13.470	AVCA-OOL-02
 Fumed Oak, Oiled	11.872	14.840	AVCA-OFU-02

Weaved Seat, Solid Back

 Oak, White Oiled	10.776	13.470	AVCA-OWO-01
 Oak, Oiled	10.776	13.470	AVCA-OOL-01
 Fumed Oak, Oiled	11.872	14.840	AVCA-OFU-01

Notes:

- The COM option for seat adds 1.500 DKK plus material to the net price.
- Approved EN 16139 for extreme use.
- Felt gliders.
- Fumed colors will vary across the chair as the wood content of tanin will vary.
Read more under material information.

Dimensions

Height	820 mm
Width	550 mm
Seat Height	460 mm
Seat Depth	450 mm
Arm Height	653 mm
Box	630 x 590 x 900 mm
Weight	7,5 kg

Arv Lounge Chair
David Thulstrup

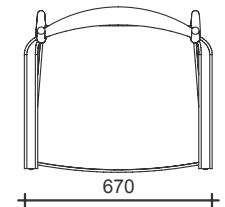
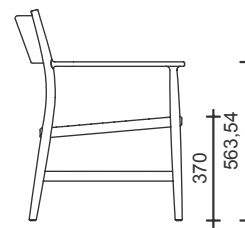
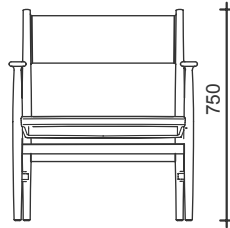

Weaved Seat, Weaved Back

	DKK ex. VAT	DKK incl. VAT	#Reference
 Oak, White Oiled	21.288	26.610	AVCL-OWO-02
 Oak, Oiled	21.288	26.610	AVCL-OOL-02
 Fumed Oak, Oiled	22.832	28.540	AVCL-OFU-02

Notes:



- Approved for hotel / restaurant (EN 15372: 2016, Test level 2 General)
- Felt gliders.
- Fumed colors will vary accross the chair as the wood content of tanin will vary.
Read more under material information.

Dimensions

Height	750 mm
Width	670 mm
Seat Depth	650 mm
Seat Height	370 mm
Box	740 x 720 x 800 mm
Weight	15 kg



	DKK ex. VAT	DKK incl. VAT	#Reference
Arv Dining Chair Cushion	1.120	1.400	AVCC
Arv Lounge Chair Cushion	1.912	2.390	AVCC-LO

	Upholstery	# Reference
	Spectrum, Brandy Leather - 30155	66
	Spectrum, Cinnamon Leather - 30146	65

Notes:

- The COM option for seat adds 1.500 DKK plus material to the net price.





Arkade Chair

by Nanna Ditzel

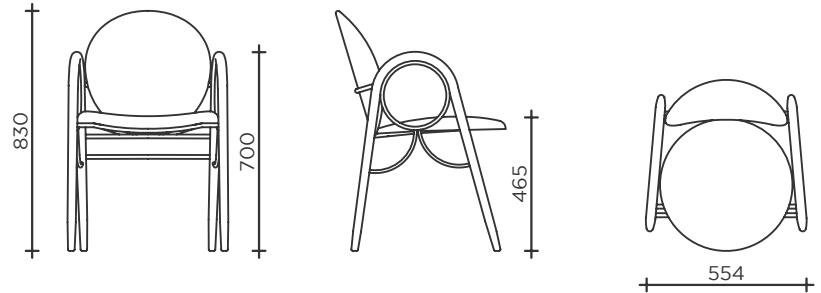





Arkade Dining Chair
Nanna Ditzel



	DKK ex. VAT	DKK incl. VAT	#Reference
 Oak, White Oiled	12.796	15.995	ARCA-OWO
 Oak, Oiled	12.796	15.995	ARCA-OOL
 Fumed Oak, Oiled	13.596	16.995	ARCA-OFU

Metal Frame Powder Coating	# Reference
 Black	BO
 Brass	BR
 Chrome	CH

Dimensions	
Height	830 mm
Width	554 mm
Seat Height	465 mm
Seat Depth	595 mm
Armrest Height	700 mm
Box	630 x 590 x 900 mm
Weight	10 kg

Upholstery	# Reference
 Spectrum, Oyster Leather - 30157	62
 Spectrum, Almond Leather - 30150	63
 Spectrum, Brandy Leather - 30155	66
 Spectrum, Cinnamon Leather - 30146	65
 Savanne, Black Leather - 30314	61
 Moss, Cream Fabric - 0019	33

Notes:

- The COM option starts from 2.000 DKK plus material to the net price.
- Felt gliders.
Read more under material information.





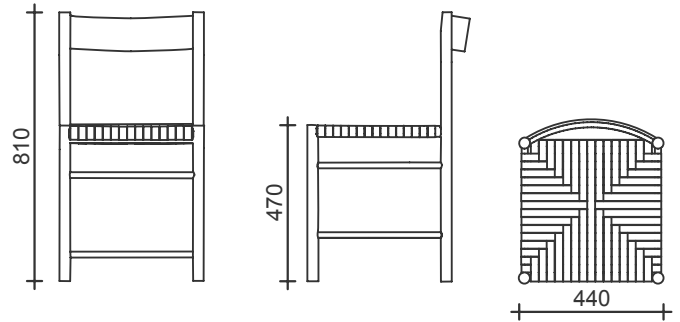

F Chair

by Rasmus B. Fex

F Dining Chair
Rasmus B. Fex



	DKK ex. VAT	DKK incl. VAT	#Reference
 Oak, Oiled, Black Webbing Seat	4.000	5.000	FCCX-OOL-11
 Fumed Oak, Oiled, Black Webbing Seat	4.400	5.500	FCCX-OFU-11
 Oak, Black Lacquer, Black Webbing Seat	4.400	5.500	FCCX-OBA-11
 Oak, Green Lacquer, Green Webbing Seat	4.400	5.500	FCCX-OGR-12
 Oak, Red Lacquer , Red Webbing Seat	4.400	5.500	FCCX-ORE-13

Notes:

- Approved for hotel / restaurant
(EN 15372: 2016, Test level 2 General)
- Felt gliders.

Dimensions

Height	810 mm
Width	440 mm
Seat Height	470 mm
Seat Width	440 mm
Box	500 x 500 x 830 mm
Weight	5 kg

F Dining Chair
Rasmus B. Fex

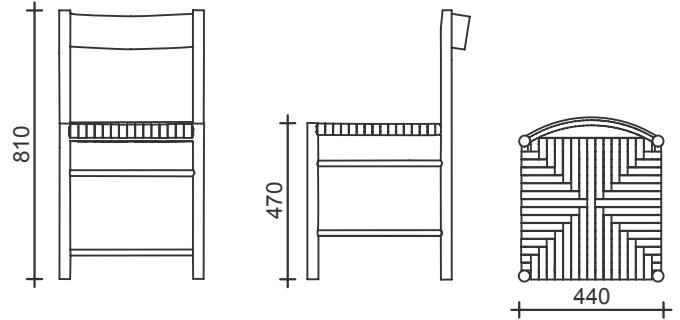

	DKK ex. VAT	DKK incl. VAT	#Reference
 Oak, Oiled, Natural Linen Webbing Seat	4.400	5.500	FCCX-OOL-04
 Fumed Oak, Oiled, Natural Webbing Seat	4.900	6.125	FCCX-OFU-04

Notes:

- Approved for hotel / restaurant (EN 15372: 2016, Test level 2 General)
- Felt gliders.





Dimensions

Height	810 mm
Width	440 mm
Seat Height	470 mm
Seat Width	440 mm
Box	500 x 500 x 830 mm
Weight	5 kg

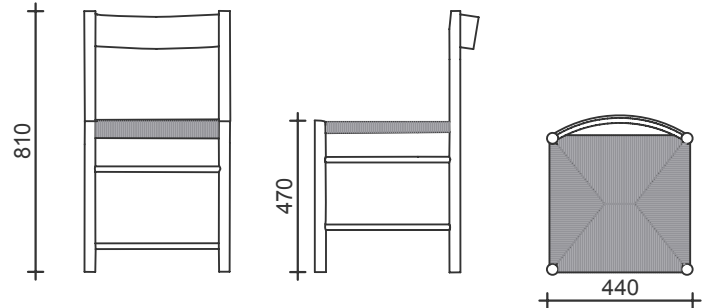
F Dining Chair with Paper Cord

Rasmus B. Fex



Paper Cord	DKK ex. VAT	DKK incl. VAT	#Reference
 Oak, Oiled	5.600	7.000	FCCX-OOL-01
 Fumed Oak, Oiled	6.000	7.500	FCCX-OFU-01
 Oak, Black Lacquer	6.000	7.500	FCCX-OBA-01
 Oak, Green Lacquer	6.000	7.500	FCCX-OGR-01
 Oak, Red Lacquer	6.000	7.500	FCCX-ORE-01

Notes:





- Approved for hotel / restaurant use:
EN 1022:2005, EN 16139:2013
- Felt gliders.
- Seat in paper cord.
The weaving is a traditional Danish triangle shape used for generations. Since cords need to overlap it is not possible to make four triangles that meet exactly in the middle - they will always overlap. Also, the four lines going from the edge of the seat to the center will never be 100 pct. straight. This is a handmade product and part of the character of the chair.

Dimensions

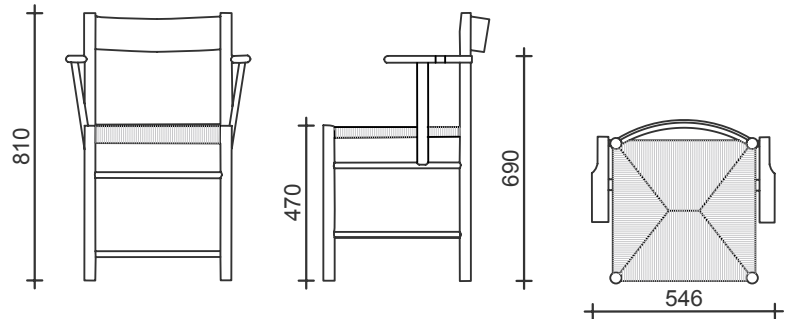
Height	810 mm
Width	440 mm
Seat Height	470 mm
Seat Width	440 mm
Box	500 x 500 x 830 mm
Weight	5 kg

F Dining Chair with Armrest
Rasmus B. Fex



	DKK ex. VAT	DKK incl. VAT	#Reference
 Oak, Oiled, Black Webbing Seat	5.200	6.500	FCCA-OOL-11
 Fumed Oak, Oiled, Black Webbing Seat	5.600	7.000	FCCA-OFU-11
 Oak, Black Lacquer, Black Webbing Seat	5.600	7.000	FCCA-OBA-11
 Oak, Green Lacquer, Green Webbing Seat	5.600	7.000	FCCA-OGR-12
 Oak, Red Lacquer, Red Webbing Seat	5.600	7.000	FCCA-ORE-13

Notes:

- Approved for hotel / restaurant (EN 15372: 2016, Test level 2 General)
- Felt gliders.

Dimensions

Height	810 mm
Width	545 mm
Seat Height	45m mm
Seat Width	470 mm
Arm Height	690 mm
Box	530 x 590 x 840 mm
Weight	5,5 kg

F Dining Chair with Armrest
Rasmus B. Fex

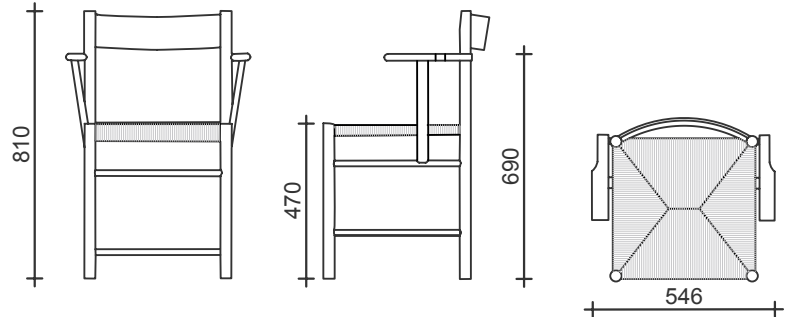

	DKK ex. VAT	DKK incl. VAT	#Reference
 Oak, Oiled, Natural Linen Webbing Seat	5.600	7.000	FCCA-OOL-04
 Fumed Oak, Oiled, Natural Linen Webbing Seat	6.100	7.625	FCCA-OFU-04

Notes:

- Approved for hotel / restaurant (EN 15372: 2016, Test level 2 General)
- Felt gliders.





Dimensions

Height	810 mm
Width	545 mm
Seat Height	45m mm
Seat Width	470 mm
Arm Height	690 mm
Box	530 x 590 x 840 mm
Weight	5,5 kg

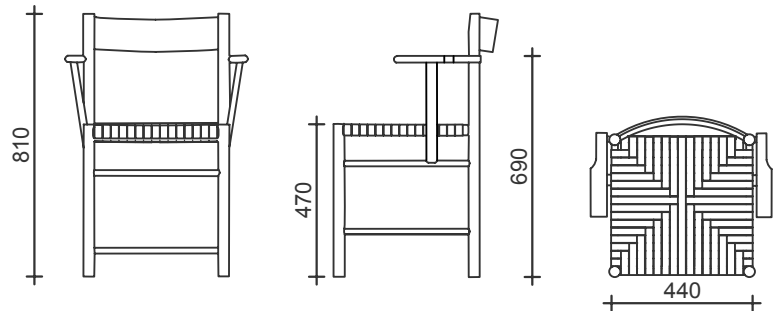
F Dining Chair with Armrest and Paper Cord

Rasmus B. Fex



Paper Cord	DKK ex. VAT	DKK incl. VAT	#Reference
 Oak, Oiled	6.800	8.500	FCCA-OOL-01
 Fumed Oak, Oiled	7.200	9.000	FCCA-OFU-01
 Oak, Black Lacquer	7.200	9.000	FCCA-OBA-01
 Oak, Green Lacquer	7.200	9.000	FCCA-OGR-01
 Oak, Red Lacquer	7.200	9.000	FCCA-ORE-01

Notes:

- Approved for hotel / restaurant use:
EN 1022:2005, EN 16139:2013
- Felt gliders.
- Seat in paper cord.
The weaving is a traditional Danish triangle shape used for generations. Since cords need to overlap it is not possible to make four triangles that meet exactly in the middle - they will always overlap. Also, the four lines going from the edge of the seat to the center will never be 100 pct. straight. This is a handmade product and part of the character of the chair.

Dimensions

Height	810 mm
Width	545 mm
Seat Height	450 mm
Seat Width	470 mm
Arm Height	690 mm
Box	530 x 590 x 840 mm
Weight	5,5 kg







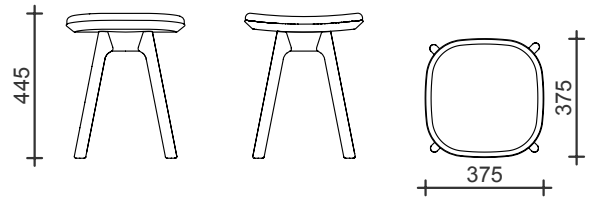

Pauline Bar Stool

by OEO Studio

Pauline Bar Stool 45 cm
OEO Studio



	DKK ex. VAT	DKK incl. VAT	#Reference
 Oak, Oiled	4.856	6.070	PA45-OOL
 Fumed Oak, Oiled	5.472	6.840	PA45-OFU

	Upholstery	# Reference
	Hallingdal, Grey Fabric - 0113	35
	Moss, Cream Fabric - 0019	33
	Spectrum, Oyster Leather - 30157	62
	Spectrum, Almond Leather - 30150	63
	Spectrum, Brandy Leather - 30155	66
	Spectrum, Cinnamon Leather - 30146	65
	Savanne, Black Leather - 30314	61

Dimensions	
Height	445 mm
Seat Width	375 mm
Seat Depth	375 mm
Box	420 x 420 x 500 mm
Weight	5 kg



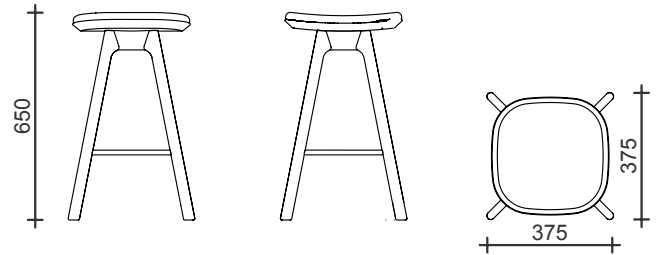

Notes:

- The COM option for seat adds 1.000 DKK plus material to the net price.
- Felt gliders.
- Approved for hotel / restaurant use: EN 1022:2005, EN 16139:2013.

Pauline Bar Stool 65 cm
OEO Studio



	DKK ex. VAT	DKK incl. VAT	#Reference
 Oak, Oiled	6.920	8.650	PA65-OOL
 Fumed Oak, Oiled	7.536	9.420	PA65-OFU

	Upholstery	# Reference
	Hallingdal, Grey Fabric - 0113	35
	Moss, Cream Fabric - 0019	33
	Spectrum, Oyster Leather - 30157	62
	Spectrum, Almond Leather - 30150	63
	Spectrum, Brandy Leather - 30155	66
	Spectrum, Cinnamon Leather - 30146	65
	Savanne, Black Leather - 30314	61

Dimensions	
Height	650 mm
Seat Width	375 mm
Seat Depth	375 mm
Box	420 x 420 x 700 mm.
Weight	6 kg





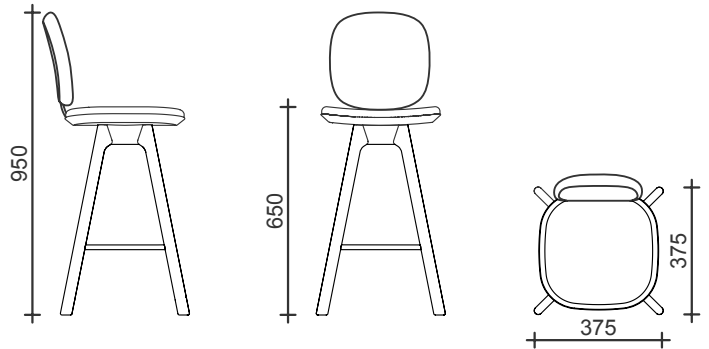

Notes:

- The COM option for seat adds 1.000 DKK plus material to the net price.
- Felt gliders.
- Approved for hotel / restaurant use: EN 1022:2005, EN 16139:2013.

Pauline Comfort Bar Stool 65 cm
OEO Studio



	DKK ex. VAT	DKK incl. VAT	#Reference
 Oak, Oiled	9.392	11.740	PA66-OOL
 Fumed Oak, Oiled	10.008	12.510	PA66-OFU

	Upholstery	# Reference
	Hallingdal, Grey Fabric - 0113	35
	Moss, Cream Fabric - 0019	33
	Spectrum, Oyster Leather - 30157	62
	Spectrum, Almond Leather - 30150	63
	Spectrum, Brandy Leather - 30155	66
	Spectrum, Cinnamon Leather - 30146	65
	Savanne, Black Leather - 30314	61

Dimensions	
Height	950 mm
Seat Height	650 mm
Seat Width	375 mm
Seat Depth	375 mm
Box	490 x 490 x 1000 mm.
Weight	8 kg







Notes:

- The COM option for seat and back adds 1.500 DKK plus material to the net price.
- Felt gliders.
- Approved for hotel / restaurant use: EN 1022:2005, EN 16139:2013.

Pauline Bar Stool 65 cm with metal legs
OEO Studio



	DKK ex. VAT	DKK incl. VAT	#Reference
 Oak, Oiled	5.392	6.740	PA65-OOL-BM
 Fumed Oak, Oiled	6.008	7.510	PA65-OFU-BM

	Upholstery	# Reference
	Hallingdal, Grey Fabric - 0113	35
	Moss, Cream Fabric - 0019	33
	Spectrum, Oyster Leather - 30157	62
	Spectrum, Almond Leather - 30150	63
	Spectrum, Brandy Leather - 30155	66
	Spectrum, Cinnamon Leather - 30146	65
	Savanne, Black Leather - 30314	61

Dimensions	
Height	650 mm
Seat Width	375 mm
Seat Depth	375 mm
Box	420 x 420 x 700 mm.
Weight	5 kg





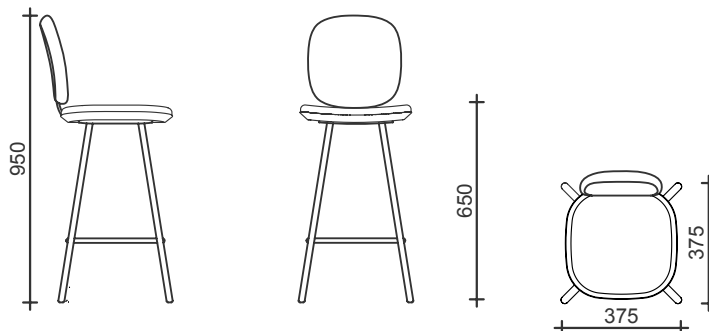

Notes:

- The COM option for seat adds 1.000 DKK plus material to the net price.
- Felt gliders.
- Approved for hotel / restaurant use: EN 1022:2005, EN 16139:2013.
- Powder coated, matt, steel legs and footrest.

Pauline Comfort Bar Stool 65 cm with metal legs
OEO Studio



	DKK ex. VAT	DKK incl. VAT	#Reference
 Oak, Oiled	7.864	9.830	PA66-OOL-BM
 Fumed Oak, Oiled	8.480	10.600	PA66-OFU-BM

Upholstery	# Reference
 Hallingdal, Grey Fabric - 0113	35
 Moss, Cream Fabric - 0019	33
 Spectrum, Oyster Leather - 30157	62
 Spectrum, Almond Leather - 30150	63
 Spectrum, Brandy Leather - 30155	66
 Spectrum, Cinnamon Leather - 30146	65
 Savanne, Black Leather - 30314	61

Dimensions	
Height	950 mm
Seat Height	650 mm
Seat Width	375 mm
Seat Depth	375 mm
Box	490 x 490 x 1000 mm.
Weight	8 kg

Notes:

- The COM option for seat adds 1.500 DKK plus material to the net price.
- Felt gliders.
- Approved for hotel / restaurant use: EN 1022:2005, EN 16139:2013.
- Powder coated, matt, steel legs and footrest.

Pauline Bar Stool 65 cm with wooden seat
 OEO Studio



	DKK ex. VAT	DKK incl. VAT	#Reference
 Oak, Oiled	5.392	6.740	PA65-OOL-BM-05
 Fumed Oak, Oiled	6.008	7.510	PA65-OFU-BM-05

Note:

- Approved for hotel / restaurant use:
 EN 1022:2005, EN 16139:2013.
- Plastic glider.
- Steel legs and footrest, powder coated matt black.
- Seat in solid oak.





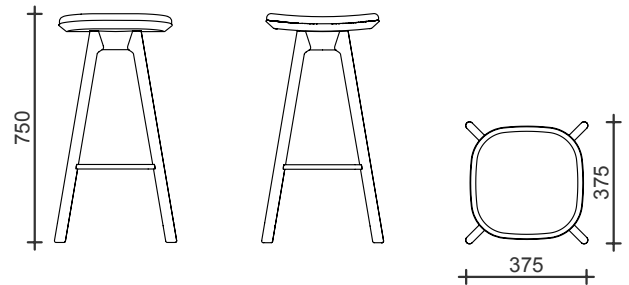

Dimensions

Height	650 mm
Seat Width	375 mm
Seat Depth	375 mm
Box	420 x 420 x 700 mm
Weight	8 kg

Pauline Bar Stool 75 cm
OEO Studio



	DKK ex. VAT	DKK incl. VAT	#Reference
 Oak, Oiled	6.920	8.650	PA75-OOL
 Fumed Oak, Oiled	7.536	9.420	PA75-OFU

	Upholstery	# Reference
	Hallingdal, Grey Fabric - 0113	35
	Moss, Cream Fabric - 0019	33
	Spectrum, Oyster Leather - 30157	62
	Spectrum, Almond Leather - 30150	63
	Spectrum, Brandy Leather - 30155	66
	Spectrum, Cinnamon Leather - 30146	65
	Savanne, Black Leather - 30314	61

Dimensions	
Height	750 mm
Seat Width	375 mm
Seat Depth	375 mm
Box	490 x 490 x 800 mm
Weight	6,5 kg





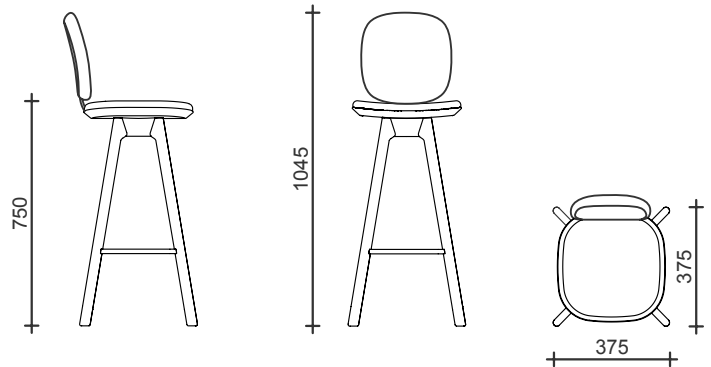

Notes:

- The COM option for seat adds 1.000 DKK plus material to the net price.
- Felt gliders.
- Approved for hotel / restaurant use: EN 1022:2005, EN 16139:2013.

Pauline Comfort Bar Stool 75 cm
OEO Studio



	DKK ex. VAT	DKK incl. VAT	#Reference
 Oak, Oiled	9.392	11.740	PA76-OOL
 Fumed Oak, Oiled	10.008	12.510	PA76-OFU

	Upholstery	# Reference
 Hallingdal, Grey Fabric - 0113		35
 Moss, Cream Fabric - 0019		33
 Spectrum, Oyster Leather - 30157		62
 Spectrum, Almond Leather - 30150		63
 Spectrum, Brandy Leather - 30155		66
 Spectrum, Cinnamon Leather - 30146		65
 Savanne, Black Leather - 30314		61

Dimensions	
Height	1045 mm
Seat Height	750 mm
Seat Width	375 mm
Seat Depth	375 mm
Box	490 x 490 x 1100 mm.
Weight	8,5 kg





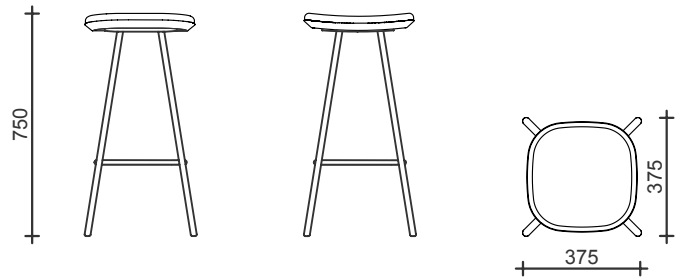

Notes:

- The COM option for seat and back adds 1.500 DKK plus material to the net price.
- Felt gliders.
- Approved for hotel / restaurant use: EN 1022:2005, EN 16139:2013.

Pauline Bar Stool 75 cm metal legs
OEO Studio



	DKK ex. VAT	DKK incl. VAT	#Reference
 Oak, Oiled	5.392	6.740	PA75-OOL-BM
 Fumed Oak, Oiled	6.008	7.510	PA75-OFU-BM

	Upholstery	# Reference
	Hallingdal, Grey Fabric - 0113	35
	Moss, Cream Fabric - 0019	33
	Spectrum, Oyster Leather - 30157	62
	Spectrum, Almond Leather - 30150	63
	Spectrum, Brandy Leather - 30155	66
	Spectrum, Cinnamon Leather - 30146	65
	Savanne, Black Leather - 30314	61

Dimensions	
Height	750 mm
Seat Width	375 mm
Seat Depth	375 mm
Box	490 x 490 x 800 cm
Weight	8 kg



Notes:

- The COM option for seat adds 1.000 DKK plus material to the net price.
- Felt gliders.
- Approved for hotel / restaurant use: EN 1022:2005, EN 16139:2013.
- Powder coated, matt, steel legs and footrest.

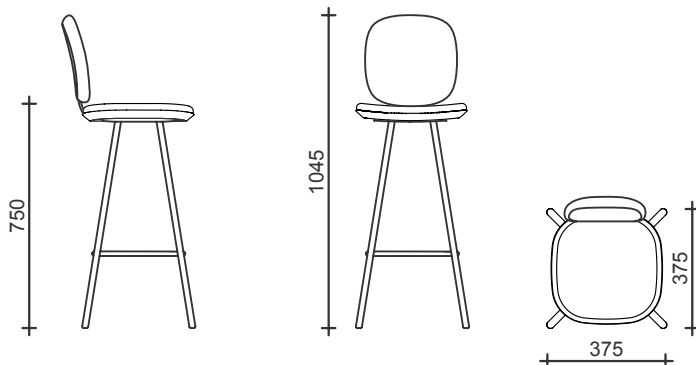
Pauline Comfort Bar Stool 75 cm metal legs
OEO Studio



	DKK ex. VAT	DKK incl. VAT	#Reference
 Oak, Oiled	7.864	9.830	PA76-OOL-BM
 Fumed Oak, Oiled	8.480	10.600	PA76-OFU-BM

	Upholstery	# Reference
	Hallingdal, Grey Fabric - 0113	35
	Moss, Cream Fabric - 0019	33
	Spectrum, Oyster Leather - 30157	62
	Spectrum, Almond Leather - 30150	63
	Spectrum, Brandy Leather - 30155	66
	Spectrum, Cinnamon Leather - 30146	65
	Savanne, Black Leather - 30314	61

Dimensions	
Height	1045 mm
Seat Height	750 mm
Seat Width	375 mm
Seat Depth	375 mm
Box	490 x 490 x 1100 mm
Weight	9,5 kg

Notes:

- The COM option for seat adds 1.500 DKK plus material to the net price.
- Felt gliders.
- Approved for hotel / restaurant use: EN 1022:2005, EN 16139:2013.
- Powder coated, matt, steel legs and footrest.

Pauline Barstol 75 cm with wooden seat
OEO Studio

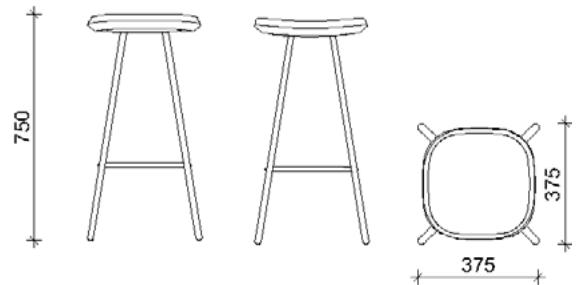

	DKK ex. VAT	DKK incl. VAT	#Reference
 Oak, Oiled	5.392	6.740	PA75-OOL-BM-05
 Fumed Oak, Oiled	6.008	7.510	PA75-OFU-BM-05

Note:

- Approved for hotel / restaurant use:
EN 1022:2005, EN 16139:2013.
- Plastic glider.
- Steel legs and footrest, powder coated matt black.
- Seat in solid oak.

Dimensions

Height	750 mm
Seat Width	375 mm
Seat Depth	375 mm
Box	490 x 490 x 800 mm
Weight	8,5 kg







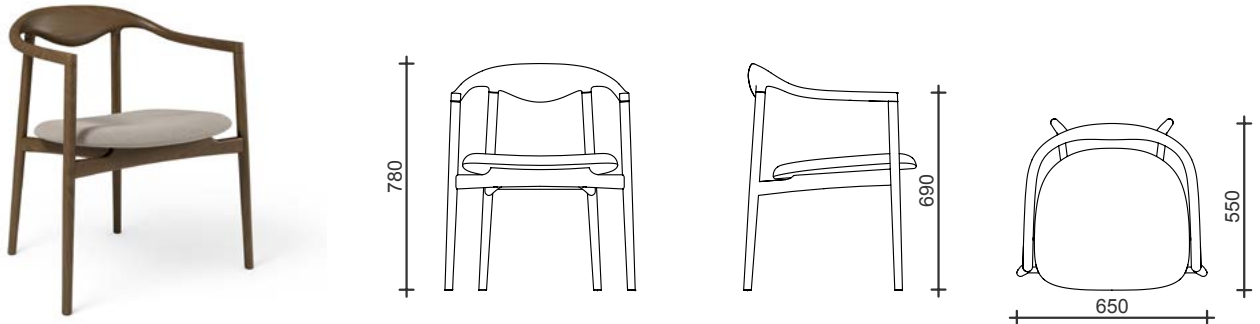

Jari Chair

by OEO Studio



	DKK ex. VAT	DKK incl. VAT	#Reference
 Oak, Oiled	16.796	20.995	JACA-OOL
 Fumed Oak, Oiled	17.596	21.995	JACA-OFU

	Upholstery	# Reference
	Spectrum, Oyster Leather - 30157	62
	Spectrum, Almond Leather - 30150	63
	Spectrum, Brandy Leather - 30155	66
	Spectrum, Cinnamon Leather - 30146	65
	Savanne, Black Leather - 30314	61
	Moss, Cream Fabric - 0019	33

Dimensions	
Height	780 mm
Width	650 mm
Seat Height	460 mm
Seat Depth	550 mm
Armrest Height	690 mm
Box	670 x 630 x 800 mm
Weight	10 kg

Notes:

- The COM seat option adds 2.000 DKK plus material to the net price.
- Felt gliders.
Read more under material information.







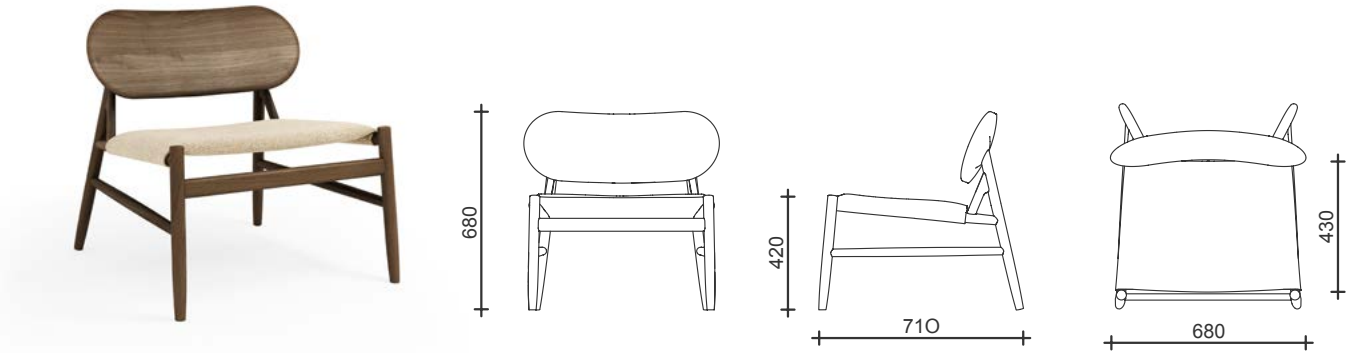

Ferdinand Lounge Chair

by OEO Studio

Ferdinand Lounge Chair
OEO Studio



	DKK ex. VAT	DKK incl. VAT	#Reference
 Oak, Oiled	25.944	32.430	FECX-OOL
 Fumed Oak, Oiled	27.144	33.930	FECX-OFU

	Upholstery	# Reference
	Spectrum, Oyster Leather - 30157	62
	Spectrum, Almond Leather - 30150	63
	Spectrum, Brandy Leather - 30155	66
	Spectrum, Cinnamon Leather - 30146	65
	Savanne, Black Leather - 30314	61
	Moss, Cream Fabric - 0019	33

Dimensions	
Height	680 mm
Width	680 mm
Seat Depth	430 mm
Seat Height	420 mm
Box	740 x 720 x 800 mm
Weight	15 kg

Notes:

- The COM seat option adds 2.000 DKK plus material to the net price.
- Felt gliders.
Read more under material information.



Karm Sofa

by David Thulstrup

Karm Lounge Chair
David Thulstrup

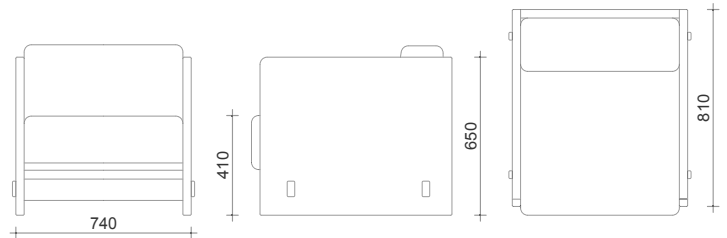

	DKK ex. VAT	DKK incl. VAT	#Reference
 Oak, Oiled	42.352	52.940	KA1S-OOL
 Fumed Oak, Oiled	44.848	56.060	KA1S-OFU

Upholstery	# Reference
 Moss, Cream Fabric - 0019	33

Dimensions	
Length	740 mm
Height	650 mm
Width	810 mm
Seat Depth	570 mm
Seat Height	420 mm

Notes:

- The very core of the KARM sofa's design comes from the strong variation in the wood that makes every piece unique. Some sofas have small or large knots and some will have a strong grain texture while others will have less.

Karm Sofa 2 Seaters
David Thulstrup

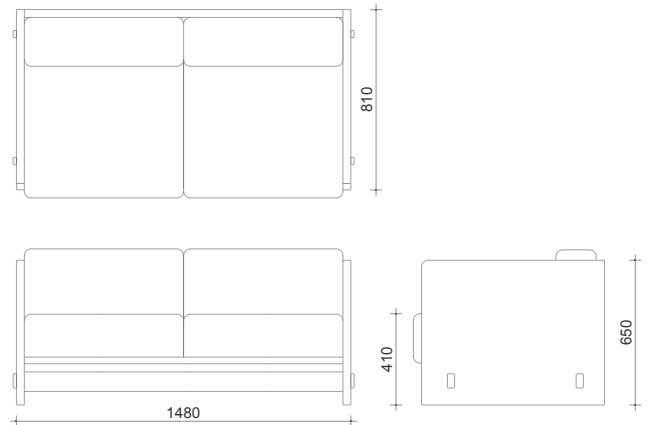

	DKK ex. VAT	DKK incl. VAT	#Reference
 Oak, Oiled	60.848	76.060	KA2S-OOL
 Fumed Oak, Oiled	65.848	82.310	KA2S-OFU

Upholstery	# Reference
 Moss, Cream Fabric - 0019	33

Dimensions	
Length	1480 mm
Height	650 mm
Width	810 mm
Seat Depth	570 mm
Seat Height	420 mm

Notes:

- The very core of the KARM sofa's design comes from the strong variation in the wood that makes every piece unique. Some sofas have small or large knots and some will have a strong grain texture while others will have less.

Karm Sofa 3 Seaters
David Thulstrup

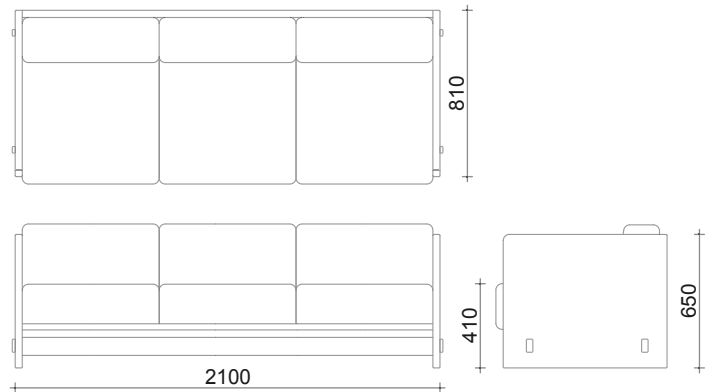

	DKK ex. VAT	DKK incl. VAT	#Reference
 Oak, Oiled	77.592	96.990	KA3S-OOL
 Fumed Oak, Oiled	83.592	104.490	KA3S-OFU

Upholstery	# Reference
 Moss, Cream Fabric - 0019	33

Dimensions	
Length	2100 mm
Height	720 mm
Width	810 mm
Seat Depth	570 mm
Seat Height	420 mm

Notes:

- The very core of the KARM sofa's design comes from the strong variation in the wood that makes every piece unique. Some sofas have small or large knots and some will have a strong grain texture while others will have less.

Lighting



Lune Lamp

by Sverre Uhnger

Lune Table Lamp
Sverre Uhnger

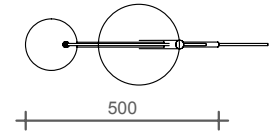
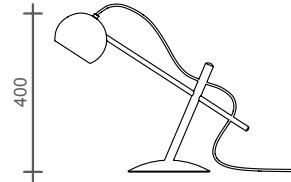
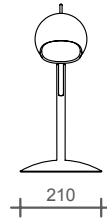

	DKK ex. VAT	DKK incl. VAT	#Reference
 Oak, White Oiled, White Electric Cord	4.796	5.995	LUTL-OWO
 Oak, Oiled, Black Electric Cord	4.796	5.995	LUTL-OOL
 Fumed Oak, Oiled, Black Electric Cord	5.596	6.995	LUTL-OFU

Notes:

- Bulb is not included.
- * LED bulb GU 10, max 6 watt.
- * Only approved for EU area.

Dimensions

Length	500 mm
Height	400 mm
Shade	Ø 140 mm
Base	210 mm
Box	590 x 390 x 240 mm
Weight	4 kg

Lune Pendant Lamp
Sverre Uhnger

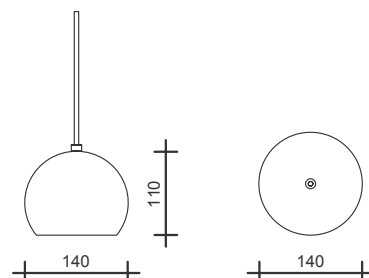

	DKK ex. VAT	DKK incl. VAT	#Reference
 Oak, White Oiled, White Electric Cord	2.796	3.495	LUPE-OWO
 Oak, Oiled, Black Electric Cord	2.796	3.495	LUPE-OOL
 Fumed Oak, Oiled, Black Electric Cord	3.256	4.070	LUPE-OFU

Notes:

- Bulb is not included.
- * LED bulb GU 10, max 6 watt.
- * Only approved for EU area.

Dimensions

Shade	Ø 140 mm
Wire	3 m
Box	200 x 200 x 260 mm
Weight	0,7 kg

Complements



	DKK ex. VAT	DKK incl. VAT	#Reference
Complete Sample Box	1.200	1.500	KCSB
Leather Sample Set	280	350	KCLES
Fabric Sample Set	136	170	KCTS
Wooden Sample (each piece)	80	100	KCWS
Compact Laminate Set	280	350	KCLAS
Metal Sample Set	280	350	KCMS
Webbing Sample Set	72	90	KCGS
Maintenance Kit	420	525	KCXX

General information



Employees

We employ a variety of people with different backgrounds, education, ethnicity, age and gender.



Education

We employ a large number of trainees and apprentices to support the industry's future.



Union

We follow the collective agreement for the largest trade union in Denmark (3F) to secure workers' rights in the production team.



Safety

Our health and safety regulation are audited on a regular basis by the Danish Working Authority.



Insurance

We offer extra health insurance for our employees and their families.



Wood

We only use certified wood - FSC © or PEFC ©.



Wind Power

Our factory buys electricity from suppliers, where the greatest possible electricity comes from Danish wind farms. This means that we only buy certified Co2 neutral electricity.



Heating

We use waste wood to generate heat - minimizing our carbon footprint.



Local

We prioritize local suppliers to minimize transport emissions.



Packaging

We only use recyclable cardboard and plastic in packaging.



Wood

Wood & Treatments

We use only certified wood from high quality suppliers. Our craftsmen choose carefully the wood for each piece of furniture. Selected wood sorts for each piece of furniture can be seen under product pages. Please note that all the models are not available in all species.



Natural Oak

North European Oak is mostly straight grained with a medium to coarse texture. It is widely used in Scandinavian furniture because of its strength.



Black Painted Oak

Paint with a semi matt finish. The grains of the oak is still visible. The top coat gives a hard protection and seals the wood.



Fumed Oak

We “home fume” every piece of furniture in our work shop. Every log has different reaction to the fuming so the color varies across each furniture.



Natural Beech

The grain of the natural beech is straight, with a fine to medium uniform texture. It is strong and durable with a good resistance to abrasion.

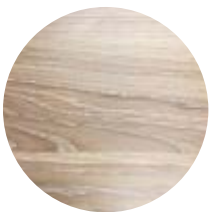

Oak White Oiled

Light pigments give the grains a brighter tint. It is water-repellent, dirt-resistant and durable.



Oiled Beech

Oil is developed from natural oils and waxes to provide the most durable protection. It brings out the warmth and depth of the wood.



Oiled Oak

Oil is developed from natural oils and waxes to provide the most durable protection. It brings out the warmth and depth of the wood.

Wood



Red Lacquered Oak

The colour and a polyurethane top coat is applied to give a semi matt finish. Lacquered oak is durable and resistant against water, moist and heat.

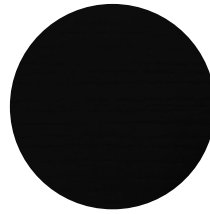

Black Lacquered Oak

The colour and a polyurethane top coat is applied to give a semi matt finish. Lacquered oak is durable and resistant against water, moist and heat.



Oiled Walnut

We use an American walnut because of its luxurious dark brown colour and its grain is revealed by a wax oil treatment.



Green Lacquered Oak

The colour and a polyurethane top coat is applied to give a semi matt finish. Lacquered oak is durable and resistant against water, moist and heat.



Oiled Cherry

American cherry is a supreme hardwood species from the U.S. hardwood forests and is unique to North America, with warm colour tones and superb finishing qualities.



White Oiled Maple

Growing naturally in the hardwood forests of North America, Maple is one of the most prolific and sustainable species with creamy to pale reddish brown and grained with a fine texture.

Compact Laminate

Compact laminate is made of special paper compressed into a firm tabletop in the process of high pressure and heat. We only use certified compact laminate of the highest quality, which our craftsmen carefully select for Bølling Tray Table. Each side of the compact laminate has a different colour. Each colour combination is selected to suit all the types of wood we use for Bølling Tray Table.



BASE

The classic model with Black and White trays has been discretely adjusted for softer contrast and a bit of warmth.

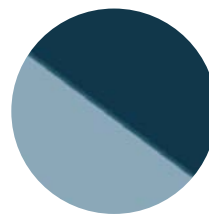

WATER

A deep marine Blue note that, like an anchor, brings calm and soothing tones to any context. On the reverse side of Water, is a brighter airy Blue, that uplifts with light contrast and tone-in-tone variation.



STONE

Two classic shades of slightly warm Grey, that will complement most settings. Each side of Stone has its own light and dark grey. In combination they bring subtle and soft contrasts.



CLAY

This vibrant burnt Orange has classic notes of terracotta and cognac leather, both complementing and uplifting its interior context. On the other side of the tray, Clays has an off-Black.



EARTH

A light caramel Beige that perfectly matches the natural tones of the oakwood frame, and comes across as monochrome, warm and modern. On the other side of the reversible tray, Earth has a dark chocolate Brown.



RED

The warm red and black provide a classic contrast and variation that both complementing and uplifting its interior context.



LEAF

Two shades of green make up the Leaf colourway. On one side of the tray is a deep dark moss-like Green, and on the other; a lighter olive Green. In combination, the two greens complement each other with soft contrast.





Upholstery

Fabric

We create a simple selection of fabrics and leather from the world's best producers considering the quality, sustainability, ethics and safety of their products. All the leathers are chosen carefully from [Sørensen Leather](#) which are originated from European rawhide and fabric from [Kvadrat](#).



Moss by Sahco , 0019

[Kvadrat](#)

Sand

Designed by Vincent van Duysen and Anna Vilhelmine Ebbesen.

Produced in Belgium.

52% cotton 22% viscose 14% polyacrylic 6% linen 3% nylon 3% polyester (worsted), 5% nylon.
50.000 Martindale



Leather

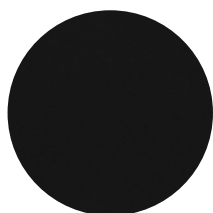

Savanne, 30314
[*Sørensen Leather*](#)

Black
Aniline Leather
Surface: Natural markings are part of the appeal
Finish Elegant matt with a soft, silky, velvety feel.

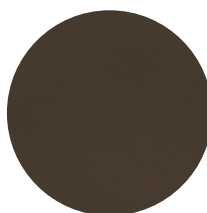

Spectrum, 30146
[*Sørensen Leather*](#)

Cinnamon
Aniline Leather
Surface: Natural markings are part of the appeal
Finish Elegant matt with a soft, silky, velvety feel.

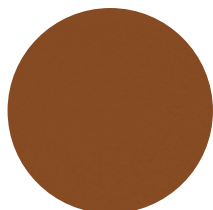

Spectrum, 30155
[*Sørensen Leather*](#)

Brandy
Aniline Leather
Surface: Natural markings are part of the appeal
Finish Elegant matt with a soft, silky, velvety feel.

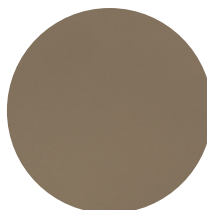

Spectrum, 30150
[*Sørensen Leather*](#)

Almond
Aniline Leather
Surface: Natural markings are part of the appeal
Finish Elegant matt with a soft, silky, velvety feel.

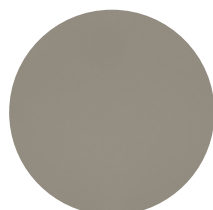

Spectrum, 30157
[*Sørensen Leather*](#)

Oyster
Aniline Leather
Surface: Natural markings are part of the appeal
Finish Elegant matt with a soft, silky, velvety feel.



Custom Upholstery Solutions

For COM and CU materials, an additional charge applies, which is detailed on each product's page in the price list. Please note that discounts do not apply to this additional charge. The customer would be responsible for supplying or paying for the fabric or leather. The measurements are based on following standards:
Fabric with 146 cm, width and 5m² leather skin.

Product	Fabric per piece	Leather per piece
JARI	75 cm	0,8 m ²
ARV	75 cm	0,8 m ²
ARKADE	110 cm	1,3 m ²
PAULINE	45 cm	0,2 m ²
PAULINE COMFORT	45 cm	0,7 m ²
FERDINAND	75 cm	0,8 m ²
KARM Lounge	2 m	X
KARM Sofa 2 seater	4 m	X
KARM Sofa 3 seater	6 m	X

General Terms & Conditions

Send an e-mail to info@brdr-kruger.dk

- Please write “order” in subject line
 - Write amount
 - Write Product number as mentioned in the price list
 - Write Upholstery Reference as mentioned in the price list
- if applicable.

You will receive an order confirmation (OC) within a few days. Please read carefully.

Brdr. Krüger is “made to order” and only carries few products in stock. Delivery time may vary, the ETD will show on OC.

Once you receive the invoice, your order is either ready for pick up, or send by forwarder and you will receive a tracing link from the chosen forwarder.

Please refer to the general terms and conditions here:
www.brdr-kruger.com/terms-and-conditions/

Contact Information



CUSTOMER SERVICE & SALES

Info@brdr-kruger.dk
T: +45 39 56 15 55
M: +45 20 93 09 59

PRESS

JONAS KRÜGER
Jonas@brdr-kruger.dk
T: +45 39 56 15 55
M: +45 30 25 61 31

PRODUCTION HQ

BRDR. KRÜGER
Walgerholm 20
DK-3500

SHOWROOM

Bredgade 28 A
DK-1260

FLAGSHIP STORE

Bredgade 28 B
DK-1260

WEBSITE:

www.brdr-kruger.com